



9-INCH ADVANCED NAVI STATION

X902D

8-INCH ADVANCED NAVI STATION

X802D-U

7-INCH ADVANCED NAVI STATION

INE-W710D

9-INCH MONITOR RECEIVER

i902D

7-INCH MONITOR RECEIVER

iLX-702D

- **OWNER'S MANUAL**
Please read before using this equipment.
- **BEDIENUNGSANLEITUNG**
Lesen Sie diese Bedienungsanleitung bitte vor Gebrauch des Gerätes.
- **MODE D'EMPLOI**
Veuillez lire avant d'utiliser cet appareil.
- **MANUAL DE OPERACIÓN**
Léalo antes de utilizar este equipo.
- **ISTRUZIONI PER L'USO**
Si prega di leggere prima di utilizzare il attrezzatura.
- **ANVÄNDARHANDLEDNING**
Innan du använder utrustningen bör du läsa igenom denna användarhandledning.
- **GEBRUIKERSHANDLEIDING**
Lees deze aanwijzingen aandachtig alvorens dit toestel te gebruiken.
- **РУКОВОДСТВО ПО ЭКСПЛУАТАЦИИ**
Прочтите настоящее руководство перед началом использования оборудования.
- **INSTRUKCJA OBSŁUGI**
Prosimy zapoznać się z tą instrukcją przed przystąpieniem do użytkowania urządzenia.

EN

DE

FR

ES

IT

SE

NL

RU

PL



MP3

AAC



(X902D/X802D-U/INE-W710D Only)

ALPINE ELECTRONICS MARKETING, INC.

1-7, Yukigaya-Otsukamachi, Ota-ku,
Tokyo 145-0067, JAPAN
Phone: 03-5499-4531

ALPINE ELECTRONICS OF AMERICA, INC.

19145 Gramercy Place, Torrance,
California 90501, U.S.A.
Phone 1-800-ALPINE-1 (1-800-257-4631)

ALPINE ELECTRONICS OF AUSTRALIA PTY. LTD.

161-165 Princes Highway, Hallam
Victoria 3803, Australia
Phone 03-8787-1200

ALPINE ELECTRONICS GmbH

Wilhelm-Wagenfeld-Str. 1-3, 80807 München, Germany
Phone 089-32 42 640

ALPINE ELECTRONICS OF U.K. LTD.

Alpine House
Fletchamstead Highway, Coventry CV4 9TW, U.K.
www.alpine.co.uk

ALPINE ELECTRONICS France S.A.R.L.

184 allée des Erables
CS 52016 – Villepinte
95 945 Roissy CDG cedex
FRANCE
Phone : + 33(0)1 48 63 89 89

ALPINE ITALIA S.p.A.

Viale Cristoforo Colombo 8,
20090 Trezzano sul Naviglio MI, Italy
Phone +39 02 484781

ALPINE ELECTRONICS DE ESPAÑA, S.A.

Portal de Gamarra 36, Pabellón, 32
01013 Vitoria (Alava)-APDO 133, Spain
Phone 945-283588

Contents

Operating Instructions

PRECAUTIONS

IMPORTANT INFORMATION, PLEASE
 READ CAREFULLY BEFORE USING THIS
 PRODUCT. (X902D/X802D-U/INE-W710D
 only) 7

WARNING

Points to Observe for Safe Usage 7
WARNING 7
CAUTION 9
NOTICE 9

Features

Favourite Function 11
 About Swiping the Touch Screen 11
 Switching the Audio Sources Screen to a
 Dedicated Screen 12
 About Dual Screen (X902D/X802D-U/
 INE-W710D only) 13
 Dual Screen Display Position 13

Getting Started

Location of Controls 14
 Turning Power On or Off 14
 Turning the System On 15
 Initial System Start-Up 15
 Adjusting the Volume 15
 Lowering Volume Quickly 15
 Touch Screen Operation 15
 Switching Sources 16
 Operating the Function Button on the Audio/
 Video Main Screen 16
 About Basic Operation for List Screen 17
 About the Shortcut Setup Screen 17
 Sound Setup Function 18
 Rear Seat Entertainment Function 18
 About the Menu Screen 19
 Edit Menu 20

About the Indicator Display 20
 Opening screen Customisation 21
 How to Input Characters and Numbers
 (Keypad) 21

Favourite Function

Using the Favourite Function 22
 Editing the Favourite Screen 22
 Registering Items 22
 Changing Item Names 23
 Changing Icons (only the Shortcut Dialing
 and Navigation icons) 23
 Changing the Layout 24
 Deleting Items 24

Applying Alpine Tunelt App

Adjusting the sound via the Smartphone 25
 Facebook Notification Function 25

Setup

Setup Operation 27

Wireless (Bluetooth) Setup

Bluetooth Setup 28
 Displaying Bluetooth Information 28
 Registering the Bluetooth Device 28
 Hands-free Device Primary/Secondary
 Setting 29
 iPhone Auto Pairing Setting 29
 Phone Setup 29
 Setting the Passcode 29
 Changing the Character Code of the Phone
 Book 29
 Selecting the Output Speaker 29
 Setting the Microphone Select (X802D-U/
 INE-W710D/iLX-702D only) 29

General Setup

Sounds Setup 30
 Setting the Balance/Fader/Rear Speaker/
 Subwoofer 31
 Setting the Media Xpander (MX HD) 31
 Equalizer Presets 32
 Adjusting the Parametric Equalizer Curve
 (Dual HD EQ) 32
 Adjusting the Crossover Settings
 (X-OVER) 33
 Adjusting the Time Correction (TCR) 33
 Setting Defeat 33

Setting the Volume for Each Source	34
Adjusting the Caller Level	34
Adjusting the Microphone Level	34
Adjusting the Ring Tone Level	34
Volume Setting	34
Auto Volume Setting	34
Setting Audio Mute On/Off while Backing up	34
Setting the Microphone Effect	34
Default Sound Settings	34
About the Crossover	35
About Time Correction	35
Visual Setup	36
Selecting the Visual EQ Mode (Factory's setting)	36
Adjusting Brightness	37
Adjusting Colour of Picture	37
Adjusting Tint of Picture	37
Adjusting Image Contrast	37
Adjusting Picture Quality	37
Saving and calling the adjusted picture quality	37
Screen Setup	37
Screen/Lighting Customise	37
Switching the Display Colour	38
Switching the Illumination Colour (X802D-U/INE-W710D/iLX-702D only)	38
Setting the Text Scroll	38
Switching the Artwork Position	38
General Setup	38
Setting the Menu Language	38
Format settings	38
Setting the Clock Display (i902D/iLX-702D only)	38
Setting the Time (i902D/ iLX-702D only) ...	39
Setting Security code	39
About X902D/X802D-U/INE-W710D/ i902D/iLX-702D	39
Setting Demo mode to Off/On	39
Car Setup	40
Steering wheel Setting	40
Installation Setup	40

Sources Setup

Radio Setup	41
PI SEEK Setting	41
Receiving RDS Regional (Local) Stations ...	41
Switching the Display Language of PTY (Programme Type)	41
Setting PTY31 (Emergency Broadcast) Reception	41

Setting the TUNER (FM) Tone Quality (Tuner Condition)	41
DAB Setting	42
Setting Alarm (Emergency Broadcast) Reception	42
Setting Announcement Reception	42
Setting the FM Linking ON/OFF (Service Following)	42
Setting the DAB Antenna ON/OFF	42
AUX Setup	43
Setting the Auxiliary (AUX) Name	43
Setting Direct Touch Operation	43
Switching the Visual Input Signal System ...	43
HDMI Setup	43
Apple CarPlay Setup	43

System Setup

Camera Setup	44
Setting the Camera Input	44
Setting the Camera Signal Input	44
Switching Video Patterns for Multi View Camera	44
Adjusting the Rear/Front/Side Camera Guide	45
Camera Interrupt Setting (Power OFF Mode) (Rear Camera Only)	46
Setting Multi Camera to On/Off	46
CAN-I/F Setup	46
Setting the Default Vehicle Screen	46
Setting the Climate Interrupt Time	46
Setting the Parking Sensor Interrupt On/Off	47
Rear Seat Entertainment Setup	47
Remote Sensor Setting	47
Unit Setup	47
Setting the External AP	47
Setting the HDMI Selector On/Off	48
Application Setup	48

Android Auto (Optional)

What is Android Auto	48
Activate Android Auto	48

Apple CarPlay (Optional)

Access to Apple CarPlay	49
-------------------------------	----

Alpine Connect App (Optional) (X902D/X802D-U/INE-W710D only)

Activate Alpine Connect App	49
-----------------------------------	----

Radio/RDS

Radio Basic Operation

Listening to the Radio	51
Presetting Stations Manually	51
Presetting Stations Automatically	51
Tuning to Preset Stations	51
Inputting Frequency Directly and Receiving the Radio Station	52

RDS Operation

Turning AF (Alternative Frequencies) On or Off	52
Interruption Function	52
Receiving Traffic Announcement	53
News Programme Interruption	53
Receiving Traffic Information Manually	53
Selecting the Receivable PTY	53
Displaying Radio Text	53

DAB/DAB+/DMB

Listening to DAB/DAB+/DMB	54
Presetting Service	55
Tuning to Preset Service	55
Service Component/PTY Search Function	55
Service Search Function	55
PTY Search Function	55
Interruption Function	56
Receiving Traffic Announcement	56
News Programme Interruption	56
Inputting Channel Number Directly and Receiving the Broadcasts	56
Switching to Secondary Service Components	56
Displaying DAB Text	57
About DAB/DAB+/DMB	57

USB Flash drive (Optional)

Playback	59
Fast-forwarding/Fast-reversing (USB Video only)	59
Stopping Playback (USB Video only)	59
Repeat Play	59
Random Play (USB Audio only)	59
Searching for a Desired Song	60
Switching Display Modes (During Video File Play Back)	60

About USB Video format	60
------------------------------	----

iPod/iPhone (Optional)

Playback	62
Searching for a Music File	62
Quick Search Mode	62
Full Search Mode	62
Alphabet Search Function	63
Repeat Play	63
Random Play (Shuffle)	63

HDMI Device (Optional)

About HDMI selector (Optional)	64
--------------------------------------	----

DVD Player Operation

DVD Player SETUP	64
------------------------	----

CD/MP3/WMA/AAC/WAV

Playback	65
Stopping Playback	65
Repeat Play	65
MIX (Random Play)	65
File/Folder Name Search (Concerning MP3/ WMA/AAC/WAV)	65
Selecting Folders (Concerning MP3/WMA/ AAC/WAV)	65
Info Mode Function	65

DVD

Playing a Disc	67
If a Menu Screen Appears	67
Numeric Keypad Input Operations	68
Displaying the Top Menu Screen	68
Displaying the Menu Screen	68
Playing Still Frames (Pausing)	68
Stopping Playback	68
Fast-forwarding/Fast-reversing	68
Finding the Beginnings of Chapters/Tracks/ Files	68
Forward/Reverse frame-by-frame Playback	69
Repeat Playback	69
Searching by Title Number	69
Searching Directly by Chapter Number	69
Switching the Angle	69
Switching the Audio Tracks	70
Switching the Subtitles (Subtitle Language)	70

Info Mode Function	70
Switching Display Modes	70

HDMI Operation

Bluetooth Operation

Setup Before Using	71
About Bluetooth	71
About the Hands-free Phone	71
Before Using Bluetooth	71

Hands-free Phone Control

Answering a Call	72
Hanging up the Telephone	72
Call Waiting Function	72
Calling	73
Calling by Favourite Function	73
Making a phone call using the Phone Menu	73
Using Voice Recognition function	74
Using Siri	74
Voice Dial Function	74
Operations During a Conversation	75
Adjusting the Speech Volume	75
Changing the Voice Output	75
DTMF (Touch-Tone) Function	75
Phone Book Function	75
Synchronising the Phone Book	75
Adding the Phone Book	75
Deleting the Phone Book Entries	76
Searching in the Phone Book	76

Bluetooth Audio

Playback	77
Repeat Play	77
Random Play	77
Search Function	77
Connecting a Bluetooth Device	78
Disconnecting the Bluetooth Connection ...	78
Changing the connecting Bluetooth Device	78

Auxiliary Device (Optional)

Operating Auxiliary Devices (Optional)	79
Operating an AUX, AUX DVD, GAME or USB Player	79
Operating an External DVD Player	79
Operating an External DVD Changer	80
Operating the Mobile Digital TV Receiver (DVB-T)	80

Operating a TV	81
----------------------	----

Camera Operation (Optional)

Rear Camera Operation	82
Displaying the Rear Camera Image from the Menu screen	82
Displaying the rear view video while the car is in reverse	82
Switching the Image Pattern for the Rear Camera	82
Guide Display ON/OFF Setting	82
Adjusting the Caution Display Location	82
About the Rear Camera Guide	83
Front Camera Operation	84
Displaying the Front Camera image from the Menu screen.	84
Switching the Image Pattern for the Front Camera	84
About the adjustment of guide display ON/OFF setting and adjustment of Caution display location	84
Side Camera Operation	85
Displaying the Side Camera image from the Menu screen	85
Switching the Image Pattern for the Side Camera	85

About Vehicle Interlock Function

Vehicle Info mode	86
Function Screen Examples	86

Information

Product Software Update	87
About the Supported Formats	87
About MP3/WMA/AAC/FLAC	87
In Case of Difficulty	89
If this Message Appears	90
Specifications	91
AUTOMOTIVE PRODUCTS END USER LICENSE PROVISIONS (X902D/X802D-U/ INE-W710D only).....	93

Operating Instructions

PRECAUTIONS

IMPORTANT INFORMATION, PLEASE READ CAREFULLY BEFORE USING THIS PRODUCT. (X902D/X802D-U/INE-W710D only)

This product is intended to safely provide turn-by-turn instructions to get you to a desired destination. Please read the following precautions to ensure that you use this navigation system correctly.

- *This product is not a substitute for your personal judgement. Any route suggestions made by this navigation system should never supersede any local traffic regulations or your personal judgement and/or knowledge of safe driving practises. Do not follow route suggestions if the navigation system instructs you to perform an unsafe or illegal manoeuvre, places you in an unsafe situation, or routes you into an area which you consider unsafe.*
- *Glance at the screen only when necessary and safe to do so. If prolonged viewing of the screen is necessary, stop in a safe and legal manner and location.*
- *Do not input destinations, change settings, or access any functions requiring a prolonged view of the monitor while you are driving. Stop in a safe and legal manner and location before attempting to access the system.*
- *When using the navigation system to find/route to an emergency service, please contact the facility to validate and verify availability, prior to driving to it. Not all locations of emergency service providers such as police and fire stations, hospitals, and clinics are contained in the database. Please use your own judgement and your ability to ask for directions in these situations.*
- *The map database used in the navigation system is the most recent map data available at the time of production. Because of changes in streets and neighbourhoods, there may be situations where the navigation system may not be able to route you to your desired destination. In these cases, use your own personal judgement.*
- *The map database is designed to provide you with route suggestions, it does not take account of the relative safety of a suggested route, or of factors which may affect the time required to reach your destination. The system does not reflect road closures or construction, road characteristics (i.e. type of road surface, slope or grade, weight or height restrictions, etc.), traffic congestion, weather conditions, or any other factors which may affect the safety or timing of your driving experience. Use your personal judgement if the navigation system is unable to provide you with an alternate route.*
- *There may be situations where the navigation system may display the vehicle's location erroneously. Use your own driving judgement in this situation, taking into account current driving conditions. Please be aware that in this situation, the navigation system should correct the vehicle's position automatically; however, there may be times where you may have to correct the position yourself. If this is the case, stop in a safe and legal manner and location before attempting operation.*
- *Make certain that the volume level of the unit is set to a level which still allows you to hear outside traffic and emergency vehicles. Driving while unable to hear outside sounds could cause an accident.*

- *Please make certain that any other person who intends on using this navigation system reads these precautions and the following instructions carefully.*

If there is anything in the manual about the operation of the navigation system which you are uncertain about, please contact your local Alpine authorised navigation dealer before using the navigation system.

WARNING

Points to Observe for Safe Usage

- *Read this manual carefully before using this disc and the system components. They contain instructions on how to use this product in a safe and effective manner. Alpine cannot be responsible for problems resulting from failure to observe the instructions in this manual.*
- *This manual uses various pictorial displays to show you how to use this product safely and to alert you to potential dangers resulting from improper connections and operation. Following are the meanings of these pictorial displays. It is important to fully understand the meanings of these pictorial displays in order to use this manual and the system properly.*



WARNING

- Operation of the system while driving is dangerous. Users should stop vehicle before operating the software.
- Road conditions and regulations take precedence over information contained on the map display; observe actual traffic restrictions and circumstances while driving.
- This software is designed for use exclusively in the unit. It cannot and may not be used in conjunction with other hardware.



WARNING

This symbol means important instructions. Failure to heed them can result in serious injury or death.

INSTALL THE PRODUCT CORRECTLY SO THAT THE DRIVER CANNOT WATCH TV/VIDEO UNLESS THE VEHICLE IS STOPPED AND THE EMERGENCY BRAKE IS APPLIED.

It is dangerous for the driver to watch TV/Video while driving a vehicle. Installing this product incorrectly enables the driver to watch TV/Video while driving. This may cause a distraction, preventing the driver from looking ahead, thus causing an accident. The driver or other people could be severely injured.

DO NOT WATCH VIDEO WHILE DRIVING.

Watching the video may distract the driver from looking ahead of the vehicle and cause an accident.

DO NOT OPERATE ANY FUNCTION THAT TAKES YOUR ATTENTION AWAY FROM SAFELY DRIVING YOUR VEHICLE.

Any function that requires your prolonged attention should only be performed after coming to a complete stop. Always stop the vehicle in a safe location before performing these functions. Failure to do so may result in an accident.

DO NOT FOLLOW ROUTE SUGGESTIONS IF THE NAVIGATION SYSTEM INSTRUCTS YOU TO PERFORM AN UNSAFE OR ILLEGAL MANEUVER, OR PLACES YOU IN AN UNSAFE SITUATION OR AREA.

This product is not a substitute for your personal judgment. Any route suggestions by this system should never supersede any local traffic regulations or your personal judgement or knowledge of safe driving practise.

KEEP THE VOLUME AT A LEVEL WHERE YOU CAN STILL HEAR OUTSIDE NOISES WHILE DRIVING.

Excessive volume levels that obscure sounds such as emergency vehicle sirens or road warning signals (train crossings, etc.) can be dangerous and may result in an accident. LISTENING AT LOUD VOLUME LEVELS IN A CAR MAY ALSO CAUSE HEARING DAMAGE.

MINIMIZE DISPLAY VIEWING WHILE DRIVING.

Viewing the display may distract the driver from looking ahead of the vehicle and cause an accident.

DO NOT DISASSEMBLE OR ALTER.

Doing so may result in an accident, fire or electric shock.

USE ONLY IN CARS WITH A 12 VOLT NEGATIVE GROUND.

(Check with your dealer if you are not sure.) Failure to do so may result in fire, etc.

KEEP SMALL OBJECTS SUCH AS SCREWS OUT OF THE REACH OF CHILDREN.

Swallowing them may result in serious injury. If swallowed, consult a physician immediately.

USE THE CORRECT AMPERE RATING WHEN REPLACING FUSES.

Failure to do so may result in fire or electric shock.

DO NOT BLOCK VENTS OR RADIATOR PANELS.

Doing so may cause heat to build up inside and may result in fire.

USE THIS PRODUCT FOR MOBILE 12V APPLICATIONS.

Use for other than its designed application may result in fire, electric shock or other injury.

MAKE THE CORRECT CONNECTIONS.

Failure to make the proper connections may result in fire or product damage.

BEFORE WIRING, DISCONNECT THE CABLE FROM THE NEGATIVE BATTERY TERMINAL.

Failure to do so may result in electric shock or injury due to electrical shorts.

DO NOT ALLOW CABLES TO BECOME ENTANGLED IN SURROUNDING OBJECTS.

Arrange wiring and cables in compliance with the manual to prevent obstructions when driving. Cables or wiring that obstruct or hang up on places such as the steering wheel, shift lever, brake pedals, etc. can be extremely hazardous.

DO NOT SPLICE INTO ELECTRICAL CABLES.

Never cut away cable insulation to supply power to other equipment. Doing so will exceed the current carrying capacity of the wire and result in fire or electric shock.

DO NOT DAMAGE PIPE OR WIRING WHEN DRILLING HOLES.

When drilling holes in the chassis for installation, take precautions so as not to contact, damage or obstruct pipes, fuel lines, tanks or electrical wiring. Failure to take such precautions may result in fire.

DO NOT USE BOLTS OR NUTS IN THE BRAKE OR STEERING SYSTEMS TO MAKE GROUND CONNECTIONS.

Bolts or nuts used for the brake or steering systems (or any other safety-related system), or tanks should NEVER be used for installations or ground connections. Using such parts could disable control of the vehicle and cause fire etc.

DO NOT INSTALL IN LOCATIONS WHICH MIGHT HINDER VEHICLE OPERATION, SUCH AS THE STEERING WHEEL OR SHIFT LEVER.

Doing so may obstruct forward vision or hamper movement etc. and results in serious accident.



CAUTION

This symbol means important instructions. Failure to heed them can result in injury or material property damage.

HALT USE IMMEDIATELY IF A PROBLEM APPEARS.

Failure to do so may cause personal injury or damage to the product. Return it to your authorized Alpine dealer or the nearest Alpine Service Centre for repairing.

HAVE THE WIRING AND INSTALLATION DONE BY EXPERTS.

The wiring and installation of this unit requires special technical skill and experience. To ensure safety, always contact the dealer where you purchased this product to have the work done.

USE SPECIFIED ACCESSORY PARTS AND INSTALL THEM SECURELY.

Be sure to use only the specified accessory parts. Use of other than designated parts may damage this unit internally or may not securely install the unit in place. This may cause parts to become loose resulting in hazards or product failure.

ARRANGE THE WIRING SO IT IS NOT CRIMPED OR PINCHED BY A SHARP METAL EDGE.

Route the cables and wiring away from moving parts (like the seat rails) or sharp or pointed edges. This will prevent crimping and damage to the wiring. If wiring passes through a hole in metal, use a rubber grommet to prevent the wire's insulation from being cut by the metal edge of the hole.

DO NOT INSTALL IN LOCATIONS WITH HIGH MOISTURE OR DUST.

Avoid installing the unit in locations with high incidence of moisture or dust. Moisture or dust that penetrates into this unit may result in product failure.



NOTICE

Product Cleaning

Use a soft dry cloth for periodic cleaning of the product. For more severe stains, please dampen the cloth with water only. Anything else has the chance of dissolving the paint or damaging the plastic.

Temperature

Be sure the temperature inside the vehicle is between +45°C (+113°F) and 0°C (+32°F) before turning your unit on.

Maintenance

If you have problems, do not attempt to repair the unit yourself. Return it to your Alpine dealer or the nearest Alpine Service Station for servicing.

Protecting the USB connector

- Only an iPod/iPhone, Android™ smartphone or USB flash drive can be connected to the USB connector on this unit. Correct performance using other USB products cannot be guaranteed.
- If the USB connector is used, be sure to use only the supplied connector cable with the unit. A USB hub is not supported.
- Depending on the connected USB flash drive, the unit may not function or some functions may not be performed.
- The audio file format that can be played back on the unit is MP3/WMA/AAC/FLAC.
- Artist/song name, etc., can be displayed. Certain, special characters may not be correctly displayed.



CAUTION

Alpine accepts no responsibility for lost data, etc., even if data, etc., is lost while using this product.

On Handling USB Flash drive

- This unit can control a memory storage device that supports the USB Mass Storage Class (MSC) protocol. Playable audio file formats are MP3, WMA, AAC and FLAC.
- USB Flash drive function is not guaranteed. Use USB flash drive according to the terms of agreement. Read the USB flash drive Owner's Manual thoroughly.
- Avoid usage or storage in the following locations:
 - Anywhere in the car exposed to direct sunlight or high temperatures.
 - Anywhere the possibility of high humidity or corrosive substances are present.
- Fix the USB flash drive in a location where driver operation will not be hindered.
- USB Flash drive may not function correctly at high or low temperature.
- Use only certified USB flash drive. Note that even certified USB flash drive, may not function correctly depending on its type or state.
- Depending on the settings of the USB flash drive type, memory state or encoding software, the unit may not play back or display properly.
- USB Flash drive may take time to start playback. If there is a particular file other than audio in the USB flash drive, it may take considerable time before the file is played back or searched.
- The unit can play back "mp3," "wma" or "m4a" file extensions.
- Do not add the above extensions to a file other than audio data. This non-audio data will not be recognised. The resulting playback may contain noise that can damage speakers and/or amplifiers.
- It is recommended to back up important data on a personal computer.
- Do not remove the USB device while playback is in progress. Change SOURCE to something other than USB, then remove the USB device to prevent possible damage to its memory.
- *Windows Media, and the Windows logo are trademarks, or registered trademarks of Microsoft Corporation in the United States and/or other countries.*
- *Apple, iPhone, iPod, and iPod touch are trademarks of Apple Inc., registered in the U.S. and other countries. Apple CarPlay is a trademark of Apple Inc.*
- *Use of the Apple CarPlay logo means that a vehicle user interface meets Apple performance standards. Apple is not responsible for the operation of this vehicle or its compliance with safety and regulatory standards. Please note that the use of this product with iPhone, or iPod may affect wireless performance.*
- *"Made for iPod," and "Made for iPhone," mean that an electronic accessory has been designed to connect specifically to iPod, or iPhone, respectively, and has been certified by the developer to meet Apple performance standards. Apple is not responsible for the operation of this device or its compliance with safety and regulatory standards. Please note that the use of this accessory with iPod, or iPhone may affect wireless performance.*
- *Google, Android, Android Auto, Google Play and other marks are trademarks of Google Inc.*
- *SPOTIFY and the Spotify logo are among registered trademarks of Spotify AB.*
- *The Bluetooth® word mark and logos are registered trademarks owned by the Bluetooth SIG, Inc. and any use of such marks by Alpine Electronics, Inc. is under licence.*
- *The terms HDMI and HDMI High-Definition Multimedia Interface, and the HDMI Logo are trademarks or registered trademarks of HDMI Licensing, LLC in the United States and other countries.*
- *MPEG Layer-3 audio coding technology licensed from Fraunhofer IIS and Thomson. Supply of this product only conveys a licence for private, non-commercial use and does not convey a licence nor imply any right to use this product in any commercial (i.e. revenue-generation) real time broadcasting (terrestrial, satellite, cable and/or any other media), broadcasting/streaming via internet, intranets and/or other networks or in other electronic content distribution systems, such as pay-audio or audio-on-demand applications. An independent licence for such use is required. For details, please visit <http://www.mp3licensing.com>*
- *©2006-2016 TomTom. All rights reserved. This material is proprietary and the subject of copyright protection, database right protection and other intellectual property rights owned by TomTom or its suppliers. The use of this material is subject to the terms of a license agreement. Any unauthorized copying or disclosure of this material will lead to criminal and civil liabilities.*

Features

The following screen examples of X902D/X802D-U/INE-W710D used in this manual are for reference only. They may differ from the actual screen displays.

Favourite Function

Frequently used functions such as the Audio source or Navigation are easily recalled. Register them to the Favourite screen. For details, see “Favourite Function” (page 22).

■ Favourite screen example

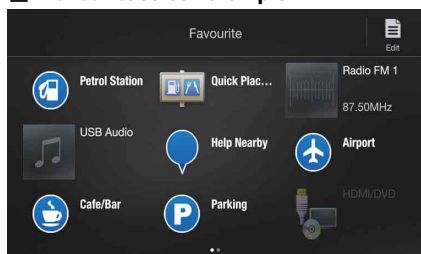

- Frequently used functions and useful functions can be customised for your convenience.
- You can register up to 54 functions.
- You cannot register a function more than once.

About Swiping the Touch Screen

You can change a screen or a page by swiping the touch screen vertically or horizontally with your finger. For details, see “Touch Screen Operation” (page 15).

Swipe the display with your finger lightly.



Switching the Audio Sources Screen to a Dedicated Screen

You can switch the Audio Sources screen to a dedicated screen by touching the icon on one of the four edges of the screen, or by swiping vertically or horizontally. For details on how to swipe the screen, see “Touch Screen Operation” (page 15).

Shortcut Setup Screen (page 17)



You can set the Sound Setup or Rear Seat Entertainment System.

Dual Screen (page 13)

(X902D/X802D-U/INE-W710D only)

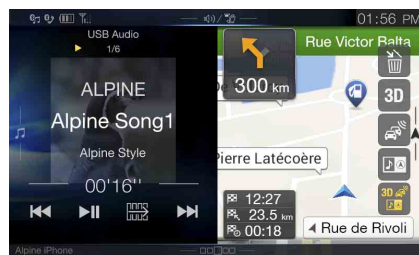

You can switch between the displayed screens on the Dual Screen.

<Audio Sources Screen>
(USB Audio)

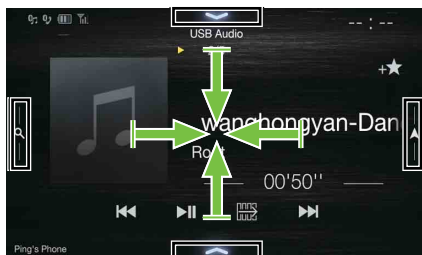

Preset button or Quick Search mode Screen *1



Menu Screen *2 (page 19)



You can make settings on the Menu Screen.

*1 The Search mode differs depending on the audio source. For details, see the operating instructions of the audio source.

*2 The screen also switches by pressing the Menu button.

About Dual Screen (X902D/X802D-U/INE-W710D only)

Dual Screen allows you to display the Navigation and Audio/Visual screens simultaneously.

Audio full Screen



Touch [🎵], or
swipe to the right.

Touch [⬆️], or
swipe to the left.

Dual Screen



Touch [🎵], or
swipe to the right.

Touch [⬆️], or
swipe to the left.

Navigation full Screen

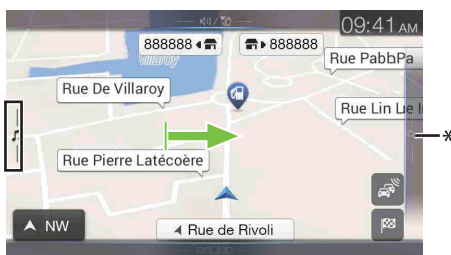

* Touch [📍], or swipe to the left to switch to the Navigation menu screen. For details of navigation operations, refer to "Navigation System OM" in the CD-ROM.

Dual Screen Display Position

You can switch the left/right positions of the Audio/Visual screen and Navigation screen. Each time you touch [📍], the positions of Audio/Visual screen and Navigation screen switch.

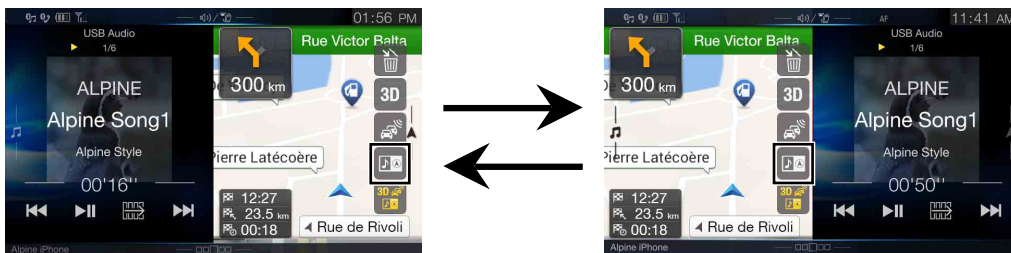

- When [📍] is not displayed, touch [📍].

Getting Started

Location of Controls

For X902D/i902D

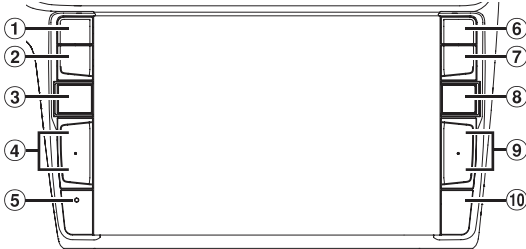

For X802D-U/INE-W710D/iLX-702D

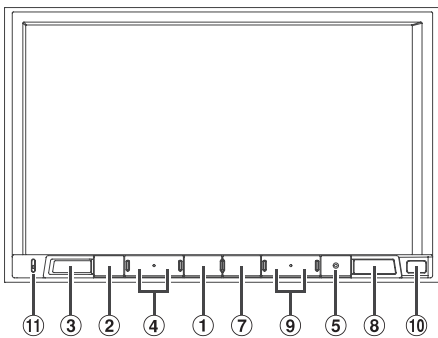

- ① **🗣️ or VOICE button**
Depending on the connected smartphone, press to recall Siri function or voice recognition mode.
- ② **🔇 (MUTE) button**
Press to activate/deactivate the mute mode.
- ③ **🎵 (AUDIO)/ (Favourite) button**
Displays the Audio/Visual screen. If the Audio/Visual screen is already displayed, changes the source.
Press and hold for at least 2 seconds to recall the Favourite screen.
- ④ **+/- or ^/∨ (UP/DOWN) button**
Press to adjust the volume.
- ⑤ **RESET switch**
The system of this unit is reset.
- ⑥ **📞 (PHONE) button (X902D/i902D only)**
Recalls the Phone Menu screen.
Press to start a conversation when a call is incoming.
- ⑦ **MENU/ (Power Off) button**
Recalls the Menu screen.
Press and hold this button for at least 5 seconds to turn the power off.

- ⑧ **📍 (NAV) button**
For X902D/X802D-U/INE-W710D:
Recalls the navigation map screen.
Press again to switch to Navigation menu screen.
Press and hold this button for at least 2 seconds to change to Go Home route screen. (If Home is not set yet, it will change to the Home setting screen.)
For details of navigation operations, refer to "Navigation System OM" in the CD-ROM.
For i902D/iLX-702D:
Recalls the connected smartphone's map screen.
Depending on the smartphone, this function may not be available.
- ⑨ **▶▶ / ◀◀ button**
Press to seek up/down a station in radio mode or up/down a track, chapter, etc., in other audio/visual sources.
- ⑩ **Remote Sensor**
Point the remote control transmitter towards the remote sensor within a range of 2 metres.
- ⑪ **Microphone (X802D-U/INE-W710D/iLX-702D only)**
Used for Hands-free or Voice Control modes.

Controllable with Remote Control

This unit can be controlled with an optional Alpine remote control. For details, consult your Alpine dealer. Point the optional remote control transmitter at the remote control sensor.

About the button descriptions used in this Owner's Manual

The buttons found on the face of the unit are expressed in bold (e.g. MENU). The buttons found on the touch-screen display are shown in bold within brackets, [] (e.g. [X]).

Turning Power On or Off

Some of this unit's functions cannot be performed while the vehicle is in motion. Be sure to stop your vehicle in a safe location and apply the parking brake, before attempting these operations.

- 1 Turn the ignition key to the ACC or ON position.**
The system turns on.
 - When turned on, the system displays the last screen that was displayed before the ignition key was turned off. For example, if the unit is in radio mode when ignition is turned off, it will remain in radio mode when ignition is turned back on.
- 2 Press and hold the MENU/ (Power Off) button for at least 5 seconds to turn the power off.**
 - The unit can be turned on by pressing any button.
 - The unit is a precision device. Careful handling of the unit should provide you with years of trouble-free operation.

Turning the System On

With the Alpine system, when the ignition key is turned to ACC or ON, the opening screen will be automatically displayed.

When the system is used for the first time, the language selection menu is displayed. Swipe the Language list screen vertically, then touch your choice from the list of 23 languages.

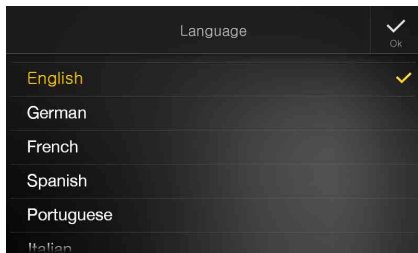

For i902D/iLX-702D:

After selecting the language, the time setting screen is displayed. Touch [<] or [>] of "Hour", "Minute" to adjust the time, then touch [OK] to confirm. Touch [Reset] to reset the time.

- For i902D/iLX-702D, the GPS antenna should be connected before adjusting the time.
- Some of this unit's functions cannot be performed while the vehicle is in motion. Be sure to stop your vehicle in a safe location and apply the parking brake before attempting these operations.

Initial System Start-Up

Be sure to press the RESET switch when using the unit for the first time, after changing the car battery, etc.

- 1 Turn off the unit power.
- 2 Press the RESET switch with a ballpoint pen or similar pointed object.

For X902D/i902D

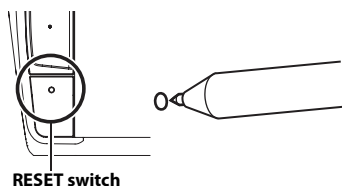

RESET switch

For X802D-U/INE-W710D/iLX-702D

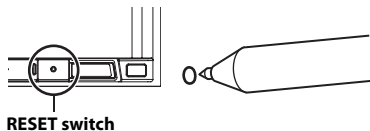

RESET switch

Adjusting the Volume

Adjust the volume by pressing +/- or ^/∨.

Volume decreases/increases continuously by pressing and holding +/- or ^/∨.

Volume: 0 - 35

Lowering Volume Quickly

Audio Mute function instantly lowers the volume level to 0.

- 1 Press the (MUTE) button to activate the MUTE mode. The audio level will be 0.
- 2 Pressing the (MUTE) button again will bring the audio back to its previous level.

Touch Screen Operation

You can operate the system by using the touch panel on the screen.

- Be sure to touch the onscreen button lightly with the pad of your finger to avoid scratching the display.

Touch operation

Touch a button or list item on the screen lightly.



- If you touch a button and there is no reaction, remove your finger.
- Onscreen buttons that cannot be operated are dimmed.

Swipe operation

Move your finger lightly with a swipe.



Drag & Drop operation

Touch and hold the desired item, then drag it to its new location by moving your finger, then release your finger to place the item.



- It is not possible to narrow the screen with two fingers (pinch in) or spread the screen (pinch out).

Switching Sources

Press the  (AUDIO) button to change the source.

Switching sources using the (AUDIO) button

During audio/visual playback, press the  (AUDIO) button repeatedly to switch to the desired source.

Radio → DAB → USB/iPod*1 → HDMI*1,2 → AUX*2,3 → Bluetooth Audio*1 → Apple CarPlay Music/Google Play Music*4 → Radio

*1 When no USB flash drive/iPod/HDMI device/Smartphone/Bluetooth compatible device is connected, this option is not available.

*2 The name set for "HDMI Setup (page 43)/AUX Setup" is displayed.

*3 When AUX is set to "Off", this option is not available. (page 43)

*4 Available when Apple CarPlay is used/Android smartphone which installed Android Auto App is connected.

To play Apple CarPlay music shall impact iPod source when an iPhone 5 or later is connected and vice versa. Refer to "Apple CarPlay Setup" (page 43).

Switching Sources from the Menu screen

1 Press the MENU button.

The menu screen is displayed.

- You can also display the menu screen by touching [] on the lower part of the Audio source screen or by swiping upward.

The Audio source selecting area



2 Touch your desired source in the Audio source selecting area.

- In the menu screen, you can change the Audio source directly or change the order in which sources change. For details, see "About the Menu Screen" (page 19).

Operating the Function Button on the Audio/Video Main Screen

Using the Function button on the Audio/Visual main screen.

Touch [] to change to the Function mode.

Radio main screen example



Function mode



Swipe to the right or left to change to the Function mode.

To close the Function mode, touch [].

- Depending on the Audio source, the Function mode displays from the beginning.

About Basic Operation for List Screen

Basic operations on the Setup list screen and the Search list screen. How to display on the list screen differs depending on the selected item.

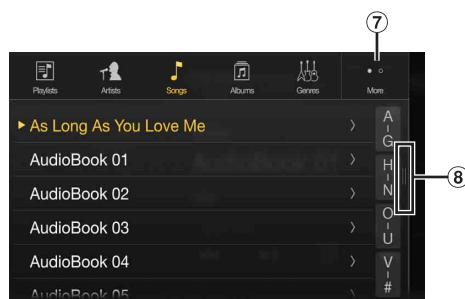

- ① Switches to the menu screen or the previous screen.
- ② Item select button
- ③ Closes the window.
- ④ Displays the next list page.
 - When the next selection item does not exist, the list item is not displayed.
- ⑤ Lists items for selection
 - When there are more than five list items, the page can be changed by swiping vertically.
- ⑥ Returns to the list screen of the page that you touched.
 - The list screens that can be displayed are up to the 2 previous pages. If you touch [<], you can recall your desired page.
- ⑦ Changes the page of the Item select button ② above.
 - “•” indicates the total number of pages, “◦” indicates the location of the current page.
- ⑧ List screen close button
 - Touch or swipe to the left on the search screen, etc. to close the list screen.

About the Shortcut Setup Screen

Displaying the Sound Setup screen, or the Shortcut Setup screen of the Rear Seat Entertainment System screen.

Touch [√] or swipe downward in the Audio source screen.



The Sound Setup screen or the Rear Seat Entertainment System Setup Screen is displayed.

■ Sound Setup screen (Tone Adjustment mode) example



- ① You can adjust the attention tone (Ding) before the voice navigation starts and Navi voice interrupt volume (Navi Guide). (X902D/X802D-U/INE-W710D only)
Volume: 0 - 35
 - ② Button for Display Off *
 - ③ Displays the registered Bluetooth Device List screen.
 - See “Registering the Bluetooth Device” (page 28).
 - ④ Touch this or swipe upward to change to the currently playing source screen.
 - ⑤ Displays the Hands-free Device Primary/Secondary setting screen.
 - See “Hands-free Device Primary/Secondary Setting” (page 29).
- * Display Off mode
- To cancel Display Off mode, touch the screen or press any button.
 - Display Off mode is cancelled when the power or ACC is turned off.
 - When the gear lever is shifted to the reverse (R) position and the rear camera is connected, the rear camera image is displayed.
 - When a call is received on a Bluetooth-connected phone, the incoming call screen is displayed.

Sound Setup Function

Tone Adjustment mode

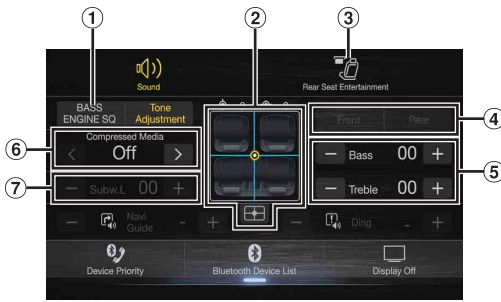

BASS ENGINE SQ mode



- ① Button for changing the BASS ENGINE SQ mode screen
- ② Balance/Fader Image area*1
- ③ Rear Seat Entertainment Function screen switch button
 - When Setting the Rear Seat Entertainment is "Off," you cannot change the screen. For details on Rear Seat Entertainment setting, see "Rear Seat Entertainment Setup" (page 47).
- ④ Buttons for switching between Front/Rear when adjusting Bass/Treble*2
- ⑤ Buttons for adjusting Bass Level/Treble Level*3, 4
- ⑥ Buttons for adjusting Media Xpander *1, 3
- ⑦ Buttons for adjusting Subwoofer Level *1, 3, 5
- ⑧ Button for changing the Tone Adjustment mode screen
 - If changing to the Tone Adjustment mode, BASS ENGINE SQ mode will be disabled.
- ⑨ Buttons for adjusting the BASS ENGINE Level*4
- ⑩ Buttons for selecting the BASS ENGINE type *4

*1 You can perform a more detailed set up in "Sounds Setup" (page 30).

*2 You cannot switch when Front/Rear Sync in "Adjusting the Parametric Equalizer Curve (Dual HD EQ)" (page 32) is "On."

*3 When you switch to the BASS ENGINE SQ mode, the value you have set is ignored.

*4 When the Defeat setting is "On," you cannot perform the set up.

*5 If the Subwoofer setting is "Off," the setting cannot be changed. See "Turning Subwoofer ON/OFF" (page 31).

Adjusting Bass Level/Treble Level

Bass Level and Treble Level can be set for each front seat and for each rear seat by touching [Front] or [Rear].

Setting item:

Bass / Treble

Setting contents:

-14 to +14 (Initial setting: 0)

- When the Sound Setup of the Shortcut Setup is selected to "BASS ENGINE SQ," you cannot perform the set up.
- Adjustment cannot be performed when Defeat is set to "On."

- The Bass adjusted setting value is interlinked with Band2 of Dual HD EQ, and the Treble adjusted setting value is interlinked with Band8.

Setting the BASS ENGINE SQ

Setting the BASS ENGINE Type

Creating the ideal Bass impact for your musical taste using BASS ENGINE SQ.

Setting contents:

Standard (Initial setting) / Punch / Rich / Mid Bass / Low Bass

Standard: Mild low-end boost with mid-range focus for front-centre staging.

Punch: Mid-bass punched up with mid-range impact.

Rich: Accented highs and mid-bass giving outstanding balance for all types of music.

Mid Bass: Strong high frequency emphasis with mid-bass boost for more low-end attack.

Low Bass: Strong, low-bass boost with extended highs for a very dynamic sound.

Adjusting the BASS ENGINE Level

You can adjust the BASS ENGINE Level.

Setting item:

BASS ENGINE Level

Setting contents:

0 to 6 (Initial setting: 3)

- The BASS ENGINE Level 0 of the BASS ENGINE SQ is common to all the types.

About setup when the external power amplifier is connected

In order to optimise the BASS ENGINE SQ mode, we recommend the following procedure to set up the power amplifier.

Use your favourite music to make the following amplifier adjustment.

- 1) Set GAIN of the power amplifier to "MIN."
- 2) Set the Crossover Mode Sector switch to "OFF."
 - If the switch has no "OFF" position, set as near as possible to full range.
- 3) Set the BASS ENGINE Level to "03."
- 4) Play a song of the genre you frequently listen to, and adjust GAIN of the power amplifier.

Rear Seat Entertainment Function

The Rear Seat Entertainment function independently routes different sources to the front and the rear side of the car. For example, while listening to the radio or other audio sources in the front, HDMI can be enjoyed at the rear with optional rear monitors and headphones.

Rear Seat Entertainment System Setup screen

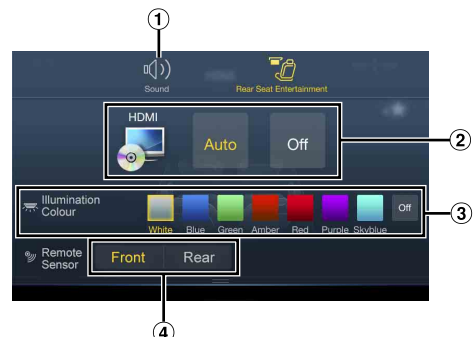

- ① Button for changing to the Sound Setup screen.
- ② Visual source selection area that is displayed on the Rear monitor.*1
Touch the source icon displayed on the Rear monitor.
Auto: The image and sound of the same visual source as the unit are output.
Off: Stops output to the Rear monitor.
- ③ Illumination Colour button*2
The colour coordination select button of the Rear monitor:
White/Blue/Green/Amber/Red/Purple/Skyblue/Off
(This function depends on Over Head Monitor)
- ④ Remote Sensor
You can set whether the sensor on Rear monitor receives remote control operation, or the unit receives it.

*1 The visual source that can be output to the Rear monitor is "HDMI/DVD." When the unit plays back the visual source, you can only select the same visual source as the unit.

*2 When the Illumination Colour in "Setting the Rear Seat Entertainment System" (page 47) is set to "Off," the Illumination Colour button is not displayed.

- During Apple CarPlay or Android Auto mode, visual source is not available for rear monitor.

About the Menu Screen

In the menu screen, you can select the audio source and perform various setups or operations on the unit.

Press the MENU button.

The menu screen is displayed.

- You can also display the menu screen by touching [^] on the lower part of the Audio source screen or by swiping upward.



Menu screen example

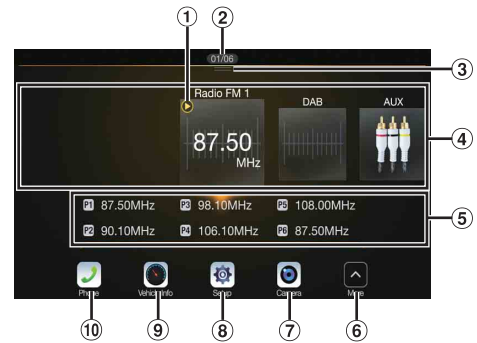

- ① Displays the currently playing audio source.
- ② Displays the total number of the audio sources that can be selected. Also displays the current position, counting from the leftmost audio source.
- ③ Touch or swipe downward to return to the Audio source screen.
- ④ Audio source select area
Touch your desired source icon to change the audio source.
 - Swiping to the right or left in the Audio source select area, you can change one audio source at a time. Moreover, swiping to the right or left outside the Audio source select area (upper and lower sides), you can change pages of the Audio source select area.
 - The source icon displayed in the Audio source select area is the one checked on the Edit menu screen. For details on how to display/hide the source icon, see "Edit Menu" (page 20).
- ⑤ Displays Preset No, and information of the Search mode, etc., located in the middle of the Audio source select area.
 - Touch the desired preset number or the Search mode to change the audio source directly.
 - The displayed information differs depending on the audio source. Some sources are not displayed.
- ⑥ Touch to display more icons. (Displayed only when icons' number over 5.)
- ⑦ Camera button*1
Displays camera images. (page 82)
- ⑧ Setup button
Displays the Setup screen. (page 27)
- ⑨ Vehicle Info button
Displays the Vehicle Info mode screen. (page 86)
- ⑩ Phone button*2
Displays the Phone menu screen. (page 71)
 - Depending on the setting and connected devices, the displayed icons and orders may differ. Touch ⑩ to display more icons such as [Notifications]*3, [Android Auto]*4, [Apple CarPlay]*5 and [Alpine Connect]*6.

*1 Displays when the Camera Select is set to "Front," "Rear," or "Other." (page 44)

*2 Displays when the Bluetooth setting is set to "On." (page 28)

*3 Use to display the Facebook Notification List on the connected smartphone via this unit. (page 26)

Displays when Alpine TuneIt App is set to "USB (iPhone)" or "Bluetooth (Android)," and when a smartphone with Alpine TuneIt App installed is connected. (page 25)

*4 Displays the Android Auto screen, displayed when an Android Smartphone installed Android Auto App is connected. (page 48)

*5 Displays the Apple CarPlay screen, displayed when Apple CarPlay is turned on and an iPhone 5 or later is connected. (page 49)

*6 Set Connectivity Setting or Alpine Connect to USB (iPhone) or Bluetooth (Android) depending on the connected Smartphone. For details, see "Alpine Connect App (Optional) (X902D/X802D-U/INE-W710D only)" (page 49).

Edit Menu

In the Edit Menu screen, you can change the audio source order or set the display/hide settings.

1 Touch the desired source icon in the Menu screen for at least 2 seconds.

A checkbox (or) is displayed on the upper left area of the source icon and switches to the edit mode.

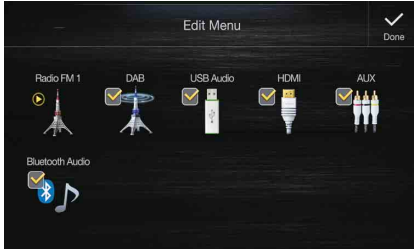

- The source icon displayed in the Edit Menu screen is displayed only when usable setup and conditions of each Audio source are fulfilled. For details on setup and conditions of each audio source, see "Switching Sources" (page 16).

Changing the order of Audio source

Drag and drop the source icon to the desired location.

Hiding/Displaying Audio source

Place a check in the checkbox () to display the Audio source icon. Uncheck the checkbox () to hide it.

- You cannot hide the icon of a source that is currently playing.

2 Touch [Done].

The editing content is confirmed, and returns to the menu screen.

- Editing here is reflected in the order of (AUDIO) button touching and change of the Audio source. (page 16)

About the Indicator Display

The Indicator Bar at the bottom of the screen displays various types of information, like the current time.



- Lights up when connected to a Bluetooth compatible device. (Does not display when connection is set to OFF.)
 : Bluetooth connection to audio device
 : Bluetooth connection to Hands Free Phone
 Blinks while reconnecting.
- Indicates the battery level of the connected Bluetooth device.

Battery Level	Level 3	Level 2	Level 1	No Battery
Icon				

This may not be displayed depending on the connected Bluetooth device. Whenever one battery level decreases, the alarm sounds.

- Indicates the signal strength level of the connected Bluetooth compatible device.
 Displayed when Bluetooth setting is ON.

0	1	2	3	No Service
				No Service

- The clock display
 You can switch between the 12 hour display and 24 hour display options.
 For details of the clock display settings, refer to "Navigation System OM" in the CD-ROM or "Setting the Clock Display (i902D/iLX-702D only)" (page 38).
- BLUETOOTH devices Name*

* When you connect two Hands-Free Phones, the information of the Bluetooth device set to Primary is displayed.

Opening screen Customisation

You can set a BMP image that is stored on a USB flash drive as the opening screen.
This setting requires the following image format, folder name and file name.

Usable file format:

- BMP image
- Image size: 800 × 480 pixels (RGB 24 bit or less/number of colour bit: 24, 8, 1 bit)
- Compression format: non-compressed
- Folder name*1: **OPENINGFILE**
- File name*2: **openingfile.bmp**

1 Connect the USB flash drive to the USB extension cable.

A message confirming the opening screen change is displayed.

2 Touch [OK].

An update indicator "⌂ (Loading)" is displayed, and update for the opening screen starts.

3 After the update is complete, the following message is displayed.*3

"Customisation succeeded. Please remove USB memory and press OK."

4 After removing the USB flash drive, touch [OK].

The opening screen setting is complete.

*1 Be sure to save the folder to the first layer of the USB flash drive.

*2 Only one BMP image can be set as the opening screen.

*3 If "Customisation failed," is displayed, touch [OK] and then check that the folder name, file name and file format are correct.

- Do not perform the following actions during the update.
 - Do not turn off the ACC to the car.
 - Do not unplug the USB flash drive.
 - Do not turn off or operate the unit.
- To return the opening screen to its original image, you must Clear All Settings. Be careful of this operation, as your other settings are also initialised. For details, see "Initializing the System" (page 39).

How to Input Characters and Numbers (Keypad)

The displayed screens and procedures may vary slightly depending on the function used, but the basic input method is the same.



- ① Input screen area.
- ② Cursor position alteration switch
- ③ Cancel
Keypad mode finishes.
- ④ (Delete)
Returns to the previous character and erases it.
Touching here for more than 2 seconds will erase all input characters.
- ⑤ Input number is confirmed.
- ⑥ Character keypad
- ⑦ Space
- ⑧ (Special character selector switch)
The Alphanumeric/Special characters/Symbols selection popup is displayed.
Touch the desired character type.

Favourite Function

Using the Favourite Function

This unit enables you to recall functions easily by registering frequently used items such as the Audio source, the navigation search function, etc. to the Favourite screen. You can recall any of these items easily.

1 Press and hold the (Favourite) button for at least 2 seconds.

The Favourite screen is displayed.

■ Favourite screen example

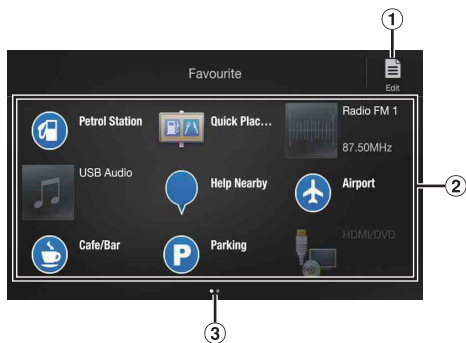

- ① Changes to the Edit screen used for registering items or changing names.
- ② Favourite registration item
Swipe to the left and right to change the pages. You can add up to 6 pages.
- ③ Indicates the location of the currently displayed Favourite screen.

2 Touch your desired Favourite registered item.

The desired item is displayed.

- When making a phone call by choosing shortcut dialing, after the message of confirmation of outgoing phone calls is displayed, touch [Call]. For details, see "Calling by Favourite Function" (page 73).

Editing the Favourite Screen

1 Touch (Edit).

A checkbox is displayed on the upper left area of the registration icon and it changes to Edit mode.



Setting item:

Item registration / Item name change / Icon change / Layout change / Item deletion

2 After editing is complete, touch (Back).

3 After the caption for the confirmation is displayed, touch [OK].

4 Editing is complete and the screen switches to the Favourite screen.

- If you touch  (Cancel) while editing, the screen switches to the previous Favourite Edit screen.

Registering Items

1 Touch (Add).

The items to be added (categories) are displayed.

2 Touch the desired item to be added (category).

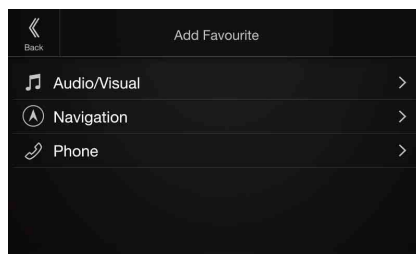

3 Choose the desired item to be added.

- You can add up to 54 items.
- You cannot register an item more than once.

■ Audio

[Radio]*1 / [DAB]*2 / [USB/iPod] / [HDMI/DVD] / [AUX] / [Bluetooth Audio] / [Apple CarPlay]*3 / [Android Auto]*3

*1 You can choose the frequency from Preset 1 - 12, registered into each FM1/FM2/MW/LW band of Radio.

*2 You can choose a channel registered to Presets 1 - 18.

*3 You can register now playing Apple CarPlay Music or Google Play Music depending on the connected Smartphone.

- You can also register directly by touching [+★] in the Audio source screen.



However, if it is already registered, [+★] is not displayed.

■ Navigation (X902D/X802D-U/INE-W710D only)

[Specific Place]:

You can display places registered in Favourite and set your destination.

[Quick Place search]:

Displays the address search keypad.

[Help Nearby]:

Displays the nearby search screen.

[POI category]:

Displays the selected POI category list.

- For details on navigation operations, refer to "Navigation System OM" in the CD-ROM.

■ Phone (Shortcut Dialing)*4

You can register the user's shortcut dialing stored in the Phone Book.

- If multiple phone numbers are stored, select a number you want to register.
- You can register directly by touching [+★] of the Contacts list. (page 71)
- You can change the icon you registered. (page 23)

*4 You can only select Phone when a Smartphone is connected.

For details on how to register a mobile phone and downloading Phone Book, see "Bluetooth Operation" (page 71).

Changing Item Names

1 Touch the text area of the registered item.

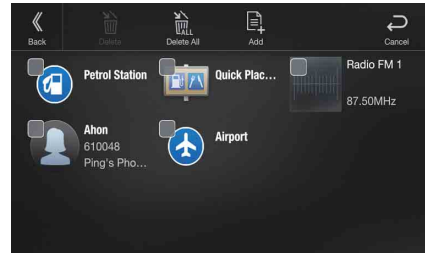

The Input User Name screen (Keypad) is displayed.

2 Input the name and touch [OK].

- For details on how to input characters using the keypad, see "How to Input Characters and Numbers (Keypad)" (page 21).

Changing Icons (only the Shortcut Dialing and Navigation icons)

You can change the icons of Shortcut Dialing and Navigation category. The following example explains how to change the Shortcut Dialing icon. Perform the same procedure to change the Navigation category icon.

1 Touch the icon that you want to change.

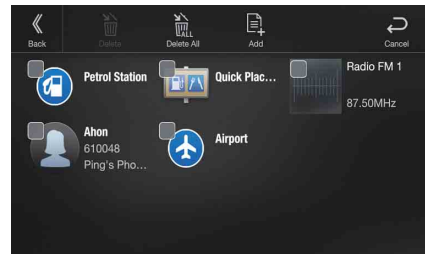

The icon list is displayed.

2 Touch the icon you want to change from the icon list.

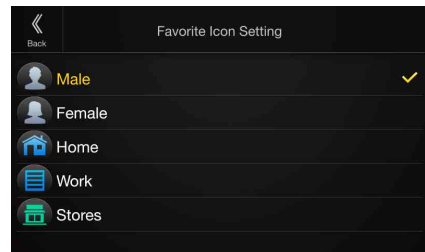

The icon is changed to the selected icon.

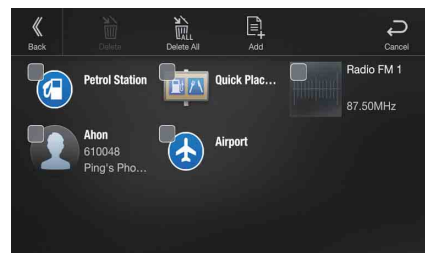

Changing the Layout

Drag and drop the item to the desired location.

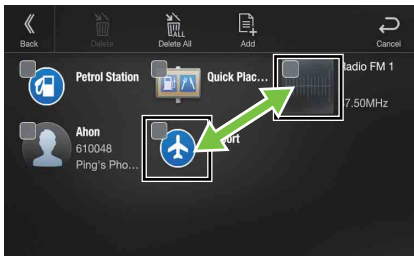

The item location is changed.

- When you move to other pages, switch pages, or when you make a new page and move to another, drag to the end of the screen, and lift your finger after the page changes.

Deleting Items

When deleting a selected item

- 1 Touch the checkbox at the left of the item you want to delete and place a check (☑) in it.**

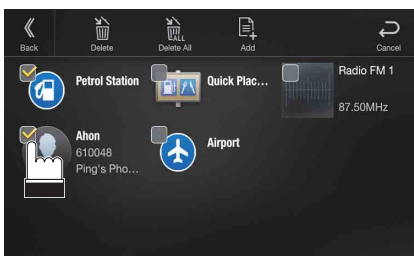

- 2 Touch [🗑️] (Delete).**

The selected item will be deleted.

When deleting all items

Touch [🗑️] (Delete All).

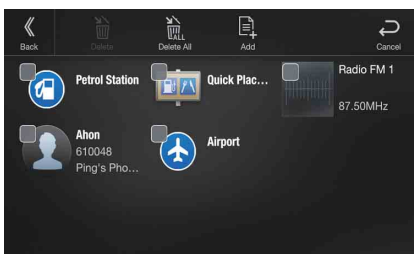

All items are deleted.

Applying Alpine TuneIt App

This unit's sound tuning is programmable from a connected Smartphone. It is also possible to download specific parameters for certain vehicles from Alpine's TuneIt database stored in the Cloud. Using the Alpine TuneIt App, customised parameters can also be uploaded for others to share and rate.

Through this unit, it is also possible to receive and respond to information from Alpine's Social Network Service (SNS) available through the connected Smartphone.

The installed Alpine TuneIt App should be launched on the Smartphone before connection to the head unit.

Alpine TuneIt App, is downloadable from Apple's App Store; the Android user can download it from Google Play. For details, consult your Alpine dealer.

Before these operations, set TuneIt to USB (iPhone) or Bluetooth (Android) depending on the connected Smartphone. For details, see "Application Setup" (page 48).

- The application programme and related specifications and data may be deleted or terminated without notice.
- Some Alpine TuneIt App functions may not be available if the Smartphone is not in a service area or receives no signal.
- Turn Apple CarPlay to Off before using Alpine TuneIt App. Refer to "Apple CarPlay Setup" (page 43).

Adjusting the sound via the Smartphone

After setting the above procedure, you can adjust the unit's sound function on the Smartphone.

1 Make sure the unit is powered on.

2 Launch the Alpine TuneIt App on the Smartphone. Adjust the unit's sound accordingly on the Smartphone.

- The setting cannot be done on both the Smartphone and this unit at the same time. While the sound function of this unit is set via Smartphone, the sound function settings on the unit will be displayed as "Sound APP Connected."
- In some situations, such as the unit is powered off or during a call, etc., sound setting cannot be done via the Smartphone.
- This function may not be available depending on the paired Smartphone.
- Please obey all local traffic laws while using this function.
- When "Setting the External AP" (page 47) is "On," this function is not available.

Facebook Notification Function

Some functions may be available in a future version of Alpine TuneIt App.

- Depending on the paired Smartphone, the following functions may not be available even though the Alpine TuneIt App version is updated.

Receiving Notification

When the smartphone connected to the unit receives new notifications from Facebook, the unit emits a notification sound or displays the notification screen. Set this up in the Alpine TuneIt App settings.

Notification Incoming screen example



- ① Poster's picture and name
Touch here to switch to Facebook screen.
Facebook screen is not displayed while driving.
- ② TTS play (Text To Speech play/stop) button
Touch to play received notification (Depending on the status, operation may not be available). During play mode, touch [TTS Stop] to stop play.
- ③ Like button
For "Like" operation. (Valid when Wall Posts or Comments is received)
- ④ Notifications List button
Touch to switch to Notifications List screen.
- ⑤ Close button
Close the notification screen.

Touch the desired button to operate.

- A new received Notification prompt will last for 15 seconds. If there is no operation within 15 seconds, the unit will return to normal mode.
- Touching the current main screen will close the notification screen.
- Volume adjustment during TTS play can be adjusted by \wedge/\vee or $\pm/\text{—}$ (0-35). Settings will be reflected at the next TTS reproduction.
- The TTS volume is output via the car's front right and left speakers.

Displaying Facebook Screen

During Notification incoming or Notification List screen, you can switch to Facebook screen.

Facebook screen example

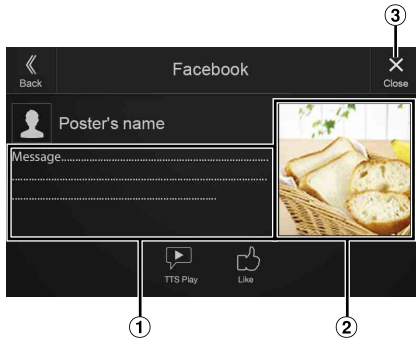

- 1 Message content
- 2 Poster's photo
- 3 Close button: Close the Facebook screen.

Touch the poster's picture and name to switch to the Facebook screen.

The detailed information of Notification is displayed.

- Touch [«] (**Back**) to return to previous screen.
- Depending on the status, contents of message and photo may not be displayed.
- In some situations, such as the unit is powered off or during a call, etc., Notification of the Smartphone will not be prompted by this unit.
- Facebook screen is not displayed while driving.

Displaying Notification List

You can view the received Notification from Facebook in the connected Smartphone via this unit.

Notification List screen example

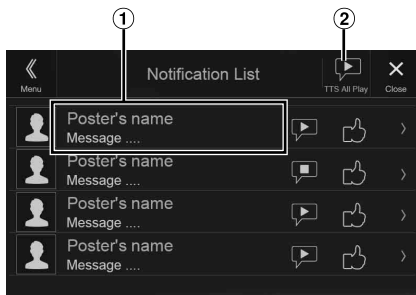

- 1 Poster's Name and Message
Messages are not displayed while driving.
- 2 Touch [TTS All Play]/[TTS All Stop] to play/stop all Notifications.

- You can switch to the Notification List screen from the Menu screen.
- Touch [X] to return to Current screen.
- Depending on the status, some functions may not be available.
- The displayable amount of the Notification list depends on the connected Smartphone.

Setup

Setup Operation

1 Press the MENU button.

The Menu screen is displayed.

- You can also display the menu screen, by touching [\wedge] on the lower part of the Audio source screen or by swiping upward.



[Setup] button

2 Touch [Setup].

The Setup main screen is displayed.



3 Touch the required setting icon on the upper part of the Setup main screen or swipe the list area vertically, then touch the setting item.

Setting items:

Wireless: See "Wireless (Bluetooth) Setup" (page 27).

General: See "General Setup" (page 30).

Sources: See "Sources Setup" (page 40).

System: See "System Setup" (page 44).

Wireless (Bluetooth) Setup

[Wireless] is selected on the Setup main screen in step 3. See "Setup Operation" (page 27).

■ Wireless Setup Menu screen

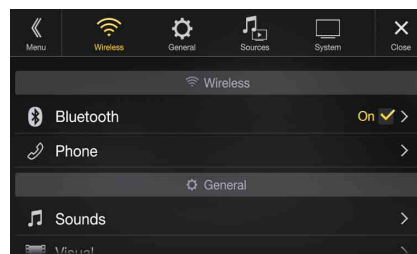

<Setting items>

Bluetooth	
Bluetooth Information*1/2	
Set Bluetooth Device*1/2	
Hands-free Device Priority*1/2	
iPhone Auto Pairing*1/2	
Phone	
Passcode Change	
Default Phonebook Encoding	
Phone Speaker	
Selection Microphone (X802D-U/INE-W710D/iLX-702D only)	

*1 This setting is only available when "Bluetooth" is set to "On" (☑).

*2 Cannot be adjusted when Apple CarPlay is used/Android smartphone which installed Android Auto App is connected, and "Bluetooth" is fixed to "On".

The following steps 1 to 3 are common to each "Setting item" of Wireless Setup. See each section for details.

1 Select the desired item.

2 To switch the setting, touch [\langle], [\rangle], [$+$], [$-$], or mark the checkboxes "Off" (☐) or "On" (☑).

- If ">" appears, there is a further hierarchy. Touch the desired item.

3 Touch [X] to return to the main source screen.

- To return to the previous List screen, touch [\ll] or [\lt] in the previous page. For details, see "About Basic Operation for List Screen" (page 17).

Bluetooth Setup

[Bluetooth] is selected on the Wireless Setup Menu screen in step 1. See “Wireless (Bluetooth) Setup” (page 27). You can register and set up Bluetooth compatible devices.



Setting item:

Bluetooth

Setting contents:

Off / On (Initial setting)

Off: Bluetooth function is not used. When the phone function is during using via Apple CarPlay or Android Auto, you cannot select “Off”.

On*: Select when you would like to pair your Bluetooth compatible phone with this unit.

* Turn this setting “On” to automatically connect a registered Bluetooth device whenever this unit is turned ON. See “Registering the Bluetooth Device” if no device is registered.

Displaying Bluetooth Information

Make sure the “Bluetooth” setting is “On” (☑). See “Bluetooth Setup” (page 28).

You can display the Bluetooth device name and device address of this unit.

Setting item:

Bluetooth Information

Registering the Bluetooth Device

Make sure the “Bluetooth” setting is “On” (☑). See “Bluetooth Setup” (page 28).

The Bluetooth device is used when a connectable Bluetooth compatible device is searched and connected from this unit, or a new Bluetooth compatible device is registered.

Setting item:

Set Bluetooth Device

1 Touch [Q] (Search) of “No Device.”



2 Touch [🎵] (Audio), [📞] (Hands-free) or [📞/🎵] (Both) of the device you want to connect from the list.

Audio: Sets for use as an Audio device.

Hands-free: Sets for use as a Hands Free Device.

Both: Sets for use as both an Audio device and Hands Free Device.

- You can register up to 5 Bluetooth compatible mobile phones.
- When you register a Hands-Free Phone for the first time, Primary is set automatically. When you connect two Hands-Free Phones, select “Hands-free” or “Both.” You can then set the priority on the Primary/Secondary setting screen. For details, see “Hands-free Device Primary/Secondary Setting” (page 29).

3 When the device registration is complete, a message appears and the device returns to normal mode.

- The Bluetooth registration process differs depending on the device version and SSP (Simple Secure Pairing). If a 4 or 6 character Passcode appears on this device, enter the Passcode using the Bluetooth compatible device.
If a 6 character Passkey appears on this device, make sure the same passkey is displayed on the Bluetooth compatible device and touch “Yes.”
- If all 5 devices have been registered, you cannot register a 6th device. To register another device, you need to delete one of the other 5 devices first.

Setting the Bluetooth Device

Select one of 5 paired Bluetooth compatible devices that you previously registered.

Touch [🎵] (Audio) or [📞] (Hands free) of the device you want to connect from the Paired Device list.



Deleting a Bluetooth Device from the list

You can delete the information of a previously connected Bluetooth compatible device.

1 Touch [🗑️] (Delete) of the Bluetooth compatible device to delete from the Paired Device list.

2 Touch [OK].

- Touching [Cancel] will cancel the setting.

Hands-free Device Primary/Secondary Setting

Make sure the “Bluetooth” setting is “On” (☑). See “Bluetooth Setup” (page 28).

When you connect two Hands-Free Phones, set the priority of the operation and the setting of incoming-outgoing calls.

Setting item:

Hands-free Device Priority

Setting contents:

Primary / Secondary

Touch the checkbox for Primary/Secondary of the device names that are registered to the unit to set them.

- When connected to two hands-free phones, operating restrictions apply to the hands-free phone registered to Secondary. For details, see “Hands-free Phone Control” (page 71).

iPhone Auto Pairing Setting

Make sure the “Bluetooth” setting is “On” (☑). See “Bluetooth Setup” (page 28).

When an iPhone is connected via USB and it is not on the Registered Device list, it will be paired automatically.

Setting item:

iPhone Auto Pairing

Setting contents:

On / Off (Initial setting)

On: Performs iPhone Auto Pairing setting.
Off: Does not perform iPhone Auto Pairing setting.

- This setting supports iPhones with iOS Ver.5.5 or later.
- When more than 5 Bluetooth devices are registered, Auto Pairing does not start.

Phone Setup

[Phone] is selected on the Wireless Setup Menu screen in step 1. See “Wireless (Bluetooth) Setup” (page 27).

You can make various settings for a Bluetooth compatible device.

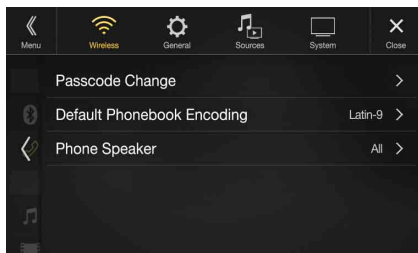

Setting the Passcode

You can set the code for connecting with a Bluetooth compatible device.

Setting item:

Passcode Change

- 1 Enter a 4-digit passcode (old), and then touch [OK].**
 - The initial number is 0000.
 - For details on how to input the numeric keypad, see “Numeric Keypad Input Operations” (page 68).
- 2 Enter a 4-digit passcode (new), and then touch [OK].**
- 3 Enter the passcode that you entered in step 2 again, and then touch [OK].**

Changing the Character Code of the Phone Book

You can select the character code that is used when transferring the phone book or history from a mobile phone. If unreadable characters appear in the transferred data, select the correct character code.

Setting item:

Default Phonebook Encoding

Setting contents:

Latin-1 / Latin-9 (Initial setting) / Russian / Chinese / Thai / Arabic / UTF-8 / UTF-16LE / UTF-16BE

Latin-1: ISO 8859-1
Latin-9: ISO 8859-15
Russian: ISO 8859-5
Chinese: GB18030
Thai: CP874
Arabic: CP1256
UTF-8
UTF-16LE
UTF-16BE

Selecting the Output Speaker

You can select which speaker in the car will output the audio from the phone.

Setting item:

Phone Speaker

Setting contents:

All (Initial setting) / Front Left / Front Right / Front Left & Right

All: The sound is output from all speakers in car.
Front Left: The sound is only output from the front left speaker.
Front Right: The sound is only output from the front right speaker.
Front Left & Right: The sound is output from the front left and front right speakers.

- The setting cannot be adjusted during a phone call. Adjust the setting before placing a call.
- This option is not available when “External AP” (page 47) is set to On.

Setting the Microphone Select (X802D-U/INE-W710D/iLX-702D only)

You can select the built-in microphone or the supplied microphone as a Hands-Free Microphone.

Setting item:

Selection Microphone

Setting contents:

Built-in / Add-on (Initial setting)

Built-in: Use the built-in microphone.
Add-on: Use the supplied microphone.

General Setup

[General] is selected on the setup main screen in step 3. See "Setup Operation" (page 27).

General Setup Menu screen

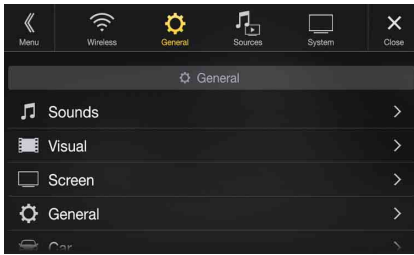

<Setting item>

Sounds	
Balance / Fader *1	
Rear Speaker*2	
Subwoofer*2	
Subwoofer Level*1, 2, 3, 5	
Subwoofer Phase*2, 3	
MX HD*1, 4, 5	
EQ Presets*4, 5	
Dual HD EQ*4, 5	
X-OVER*5	
Time Correction (TCR)	
Defeat	
Source Volume Setup	
Caller Level*6	
Microphone Level*6	
Ring Tone Level*6	
Key Sound	
Auto Volume	
Mute while backing up	
Microphone EC/NR	
Default Sound Settings	
Visual	
Video*7	
Camera*8	
Navigation (X902D/X802D-U/INE-W710D only)	
Screen	
Screen/Lighting	
Screen Colour	
Illumination Colour (X802D-U/INE-W710D/iLX-702D only)	
Text Scroll	
Artwork Position	
General	
Language	
Format Sel.	
Clock Mode (i902D/ iLX-702D only)	
Time Adjust (i902D/ iLX-702D only)	
Security Code	
About	
Demo Mode	

Car
Steering wheel
Installation Status

- *1 You can make this setting in the Sound Setup screen of the Shortcut Setup. For details, see "Sound Setup Function" (page 18).
- *2 You can also make the setting in the Bal./Fad. screen. For details on how to adjust, see "Setting the Balance/Fader/Rear Speaker/Subwoofer" (page 31).
- *3 This setting is only available when "Subwoofer" is set to "On" (☑).
- *4 When the Defeat setting is "On," you cannot perform the set up.
- *5 When the Sound Setup of the Shortcut Setup is selected to "BASS ENGINE SQ" you cannot perform the set up.
- *6 Not displayed when Apple CarPlay is used/Android smartphone which installed Android Auto App is connected.
- *7 "Video" can be selected while a video is playing.
- *8 The camera names are not displayed when Camera Select (page 44) is set to "Off".

The following steps 1 to 3 are common to each "Setting item" of General Setup. See each section for details.

- 1 Select the desired item.**
- 2 To switch the setting, touch [<], [>], [+], [-], or mark the checkboxes "Off" (☐) or "On" (☑).**
 - If ">" appears, there is a further hierarchy. Touch the desired item.
- 3 Touch [X] to return to the main source screen.**
 - To return to the previous List screen, touch [<<] or [<] in the previous page. For details, see "About Basic Operation for List Screen" (page 17).

Sounds Setup

[Sounds] is selected on the General Setup Menu screen in step 1. See "General Setup" (page 30).

You can set up items related to the sound quality.

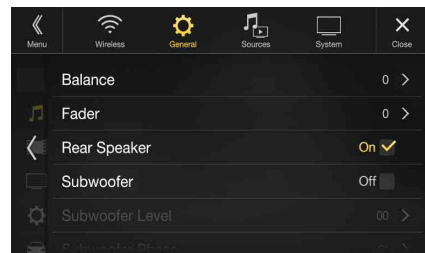

Setting the Balance/Fader/Rear Speaker/ Subwoofer

Set Balance/Fader/Rear Speaker/Subwoofer/Subwoofer Level/ Subwoofer Phase in the Bal./Fad. screen.

Setting item:

Balance*¹ / Fader*¹ / Rear Speaker / Subwoofer*² / Subwoofer Level*^{1, 2} / Subwoofer Phase*¹

*1 When selecting either of the above setting items, the Bal./Fad. screen is displayed.

*2 When the Sound Setup of the Shortcut Setup is selected to "BASS ENGINE SQ," you cannot perform the set up.

■ Fad./Bal. screen

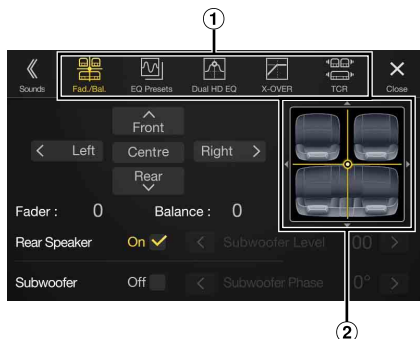

① Enables you to change to each setting screen.

② Balance/Fader Image area

Setting the Balance/Fader

Touch the desired point within the image area. Or touch [∧] [∨] [⟨] [⟩].

Balance:

L15 to R15

Fader:

F15 to R15

- To reset to the initial setting (Balance: 0, Fader: 0), touch [Centre].

Rear Speaker Setting

You can set the rear speaker output to "Off."

Setting item:

Rear Speaker

Setting contents:

On (Initial setting) / Off

Turning Subwoofer ON/OFF

If an optional subwoofer is connected to the unit, make the following setting.

Setting item:

Subwoofer

Setting contents:

On / Off (Initial setting)

Adjusting the Subwoofer Level

You can set the Subwoofer level when a Subwoofer is connected.

Setting item:

Subwoofer Level

Setting contents:

0 to 15 (Initial setting: 0)

- This setting is only available when "Subwoofer" is set to "On" (☑).

Setting the Subwoofer Phase

The subwoofer output phase is toggled Subwoofer Normal (0°) and Subwoofer Reverse (180°).

Setting item:

Subwoofer Phase

Setting contents:

0° (Initial setting) / 180°

- This setting is only available when "Subwoofer" is set to "On" (☑).

Setting the Media Xpander (MX HD)

Media Xpander (MX HD) makes vocals or instruments sound distinct regardless of the music source. The Radio (FM)/DAB, USB Flash drive and iPod/iPhone, will be able to reproduce the music clearly even in cars with a lot of road noise.

Setting item:

MX HD

- When the Defeat setting is "On," you cannot perform the set up.
- When the Sound Setup of the Shortcut Setup is selected to "BASS ENGINE SQ," you cannot perform the set up.
- The MX HD setting can be performed only when a source is currently selected.

■ Adjustable source (media) and setting value

FM/DAB: Off (Initial setting) / Level1 / Level2 / Level3

The medium to high frequencies become more clear, and produces well balanced sound in all the bands.

Compressed Media: Off (Initial setting) / Level1 / Level2 / Level3

This corrects information that was omitted at the time of compression. This reproduces a well-balanced sound close to the original.

HDMI/AUX: Off (Initial setting) / Compressed Media / Movie / Music

Choose the MX HD mode (Compressed Media, Movie, or Music) that corresponds to the media connected.

(Movie)

The dialog portion of the video is reproduced more clearly

(Music)

This disc contains a large quantity of data such as music clip. MX uses this data to reproduce the sound accurately.

- The effectiveness increases as the MX HD setting value increases Level1 → Level2 → Level3.
- You can set this for each source.
- iPod/iPhone/USB Audio/Bluetooth Audio/Apple CarPlay Music/ Google Play Music correspond to Compressed Media.

Equalizer Presets

10 typical equalizer settings are preset at the factory for a variety of musical source material.

Setting item:

EQ Presets

Setting contents:

FLAT (Initial setting) / POP / ROCK / NEWS / JAZZ / ELECTRONIC / HIP HOP / EASY LISTENING / COUNTRY / CLASSICAL

- Only one type can be set to ON.
- When Equalizer Presets is set, the linked Dual HD EQ settings are also changed. We recommend storing Dual HD EQ settings in a Preset in advance.
- The Equalizer Presets setting can be configured when Defeat is "Off."

Adjusting the Parametric Equalizer Curve (Dual HD EQ)

Parametric Equalizer (Dual HD EQ) can adjust the centre frequency/Q Adjustment (bandwidth)/level in the front seats and the rear seats, respectively.

You can adjust only to the approximate frequency zone, but can then compensate by performing advanced correction of the sound.

Setting item:

Dual HD EQ

- When the Defeat setting is "On," you cannot perform the set up.
- When the Sound Setup of the Shortcut Setup is selected to "BASS ENGINE SQ," you cannot perform the set up.

1 Adjust the Dual HD EQ to your preference.

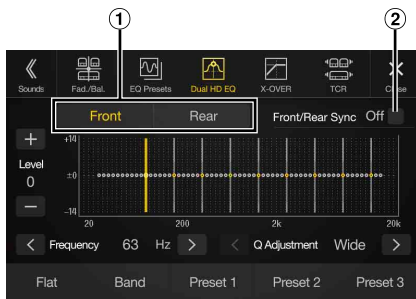

- ① Front/Rear speaker switching button
Not displayed when Front/Rear Sync is "On" (☑).

- ② Front/Rear speaker interlock button

- On: When you want the Front and Rear speakers to have the same setting, set to "On" (☑).
- Off: When you want to set the Front and Rear speakers independently, set to "Off" (☐).

Adjusting the Band

Touch [Band] to select the band to be adjusted.

Band1 → Band2 → ... → Band8 → Band9 → Band1

- You can select a band directly by touching the screen.

Adjusting the Frequency

Touch [<] or [>] of "Frequency" to adjust the frequency of the selected band.

Adjustable frequency bands:

20 Hz to 20 kHz (in 1/3 octave steps)

Band1:	20 Hz~100 Hz (63 Hz)
Band2:	63 Hz~315 Hz (125 Hz)
Band3:	125 Hz~500 Hz (250 Hz)
Band4:	250 Hz~1 kHz (500 Hz)
Band5:	500 Hz~2 kHz (1 kHz)
Band6:	1 kHz~4 kHz (2 kHz)
Band7:	2 kHz~7.2 kHz (4 kHz)
Band8:	5.8 kHz~12 kHz (8 kHz)
Band9:	9 kHz~20 kHz (16 kHz)

Adjusting the Level

Touch [-] or [+] of "Level" to adjust the level of selected band.

Setting contents:

-14 to +14 (Initial setting: 0)

Setting the Bandwidth

Touch [<] or [>] of "Q Adjustment" to select the bandwidth.

Setting contents:

Wide (Initial setting) / Medium / Narrow

2 To adjust another band, repeat step 1, and adjust all bands.

3 To store the adjusted setting value, touch and hold [Preset 1], [Preset 2], or [Preset 3] for at least 2 seconds.

- Band2 and Band8 are the same as the Bass and Treble controls.
- For details on setting Bass and Treble, see "Adjusting Bass Level/Treble Level" (page 18).
- Settings exceeding the frequency of adjacent bands are not available.
- While adjusting the Dual HD EQ, you should consider the frequency response of the connected speakers.
- When the Dual HD EQ is adjusted, the Equalizer Presets are overridden.
- When Equalizer Presets is set, the linked Dual HD EQ settings are also changed. We recommend storing Dual HD EQ settings in a Preset in advance.
- Touch [Flat] to initialise all values.

Calling the Dual HD EQ adjusted value

Calling the pre-set Dual HD EQ adjusted value.

Touch [Preset 1], [Preset 2], or [Preset 3] on the Dual HD EQ screen.

The setting stored in the Preset will be recalled.

Adjusting the Crossover Settings (X-OVER)

Before performing the following procedures, see “About the Crossover” (page 35).

Setting item:

X-OVER

- When the Sound Setup of the Shortcut Setup is selected to “BASS ENGINE SQ” you cannot perform the set up.

1 Touch [Channel] to select the channel.

Each time you touch, the channel switches.



- The channel being adjusted is displayed in red.
Front HPF → Rear HPF → Subw. LPF → Front HPF

2 Adjust the crossover to your preference.

Selecting the Cut-Off Frequency

Touch [<] or [>] of “Frequency,” and then select the cut-off frequency.

Setting contents:

20 / 25 / 31.5 / 40 / 50 / 63 / 80 (Initial setting) / 100 / 125 / 160 / 200 Hz

Adjusting the Slope

Touch [<] or [>] of “Slope,” and then adjust the HPF or LPF slope.

Setting contents:

0 (Initial setting) / 6 / 12 / 18 / 24 dB/oct.

Adjusting the Level

Touch [–] or [+] of “Level,” and then adjust the HPF or LPF level.

Setting contents:

–12 to 0 dB (Initial setting: 0)

3 Repeat steps 1 to 2 to make adjustment to the other channels.

4 To store the adjusted setting value, touch and hold [Preset 1], [Preset 2], or [Preset 3] for at least 2 seconds.

- Touch [Flat] to initialise all values.
- If the Rear Speaker setting is “Off,” the Rear Speaker setting cannot be edited (page 31).
- If the Subwoofer setting is “Off,” the Subwoofer setting cannot be edited (page 31).
- While adjusting the X-OVER you should consider the frequency response of the connected speakers.

Calling the X-OVER adjusted value

Calling the pre-set X-OVER adjusted value.

Touch [Preset 1], [Preset 2], or [Preset 3] on the X-OVER screen.

The setting stored in the Preset will be recalled.

Adjusting the Time Correction (TCR)

Before performing the following procedures, see “About Time Correction” (page 35).

Setting item:

Time Correction

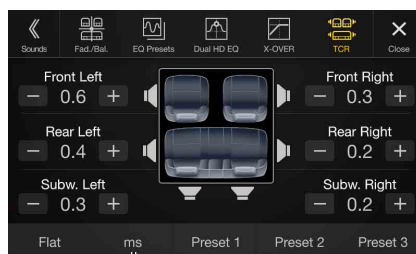

1 Touch the Correction mode button.

The pop up screen for selecting the correction mode is displayed.

2 Touch [ms], [cm] or [inch] to select the mode for making adjustments.

The selected mode is displayed on the Correction mode button.

3 Touch [–] or [+] for each speaker to adjust the time or distance.

0.0 msec to 9.9 msec (0.1 msec/step)

0.0 cm (0.0 inch) to 336.6 cm (132.7 inch) (3.4 cm/step)

All speaker setting values are adjustable in the range of 15 ms or 510 cm.

4 To store the adjusted setting value, touch and hold [Preset 1], [Preset 2], or [Preset 3] for at least 2 seconds.

- Touch [Flat] to set all values to 0.0.
- If the Rear Speaker setting is “Off,” the Rear Speaker setting cannot be edited (page 31).
- If the Subwoofer setting is “Off,” the Subwoofer setting cannot be edited (page 31).

Calling the Time Correction Value

Calling the pre-set time correction value.

Touch [Preset 1], [Preset 2], or [Preset 3] on the time correction screen.

The setting stored in the Preset will be recalled.

Setting Defeat

If Defeat is “On,” MX HD, Equalizer Presets and Dual HD EQ functions are turned Off. This disables any settings made for these functions.

Setting item:

Defeat

Setting contents:

Off (Initial setting) / On

Setting the Volume for Each Source

Setting item:

Source Volume Setup → Radio / DAB / Compressed Media*¹ / iPod Music / AUX / HDMI*² / Bluetooth Audio / Apple CarPlay / Android Auto

Setting contents*³:

-14 to +14 (Initial setting: 0)

Setting the Volume for Apple CarPlay

When an iPhone 5 or later is connected, after touching [Apple CarPlay], you can adjust Media, Phone Calls, Ringtones & Alerts level, Notifications & Guidance level, Siri and Microphone Level for Apple CarPlay mode.

Setting item:

Media / Phone Calls / Ringtones & Alerts / Notifications & Guidance / Siri / Microphone Level

Setting contents for Media:

-14 to +14 (Initial setting: 0)

Setting contents for Ringtones & Alerts:

1 to 6 (Initial setting: 3)

Setting contents for other items:

1 to 11 (Initial setting: 5)

Setting the Volume for Android Auto

When an Android Smartphone is connected, after touching [Android Auto], you can adjust Media, Phone Calls, Ringtones & Alerts level, Notifications & Guidance level, Voice Recognition and Microphone Level for Android Auto mode.

Setting item:

Media / Phone Calls / Ringtones & Alerts / Notifications & Guidance / Voice Recognition / Microphone Level

Setting contents for Media:

-14 to +14 (Initial setting: 0)

Setting contents for Ringtones & Alerts:

1 to 6 (Initial setting: 3)

Setting contents for other items:

1 to 11 (Initial setting: 5)

*1 Compressed Media is the music data in a USB flash drive (MP3/WMA/AAC/FLAC).

*2 The source name set in "HDMI Setup" (page 43) is displayed.

*3 Except for Apple CarPlay/Android Auto mode.

- Settable source differs depending on the connected device and settings.

Adjusting the Caller Level

You can adjust the volume of the incoming call.

Setting item:

Caller Level

Setting contents:

1 to 11 (Initial setting: 5)

Adjusting the Microphone Level

You can adjust the transmit volume, during the call.

Setting item:

Microphone Level

Setting contents:

1 to 11 (Initial setting: 5)

Adjusting the Ring Tone Level

You can adjust the receive volume, during the call.

Setting item:

Ring Tone Level

Setting contents:

1 to 6 (Initial setting: 3)

Volume Setting

You can change the volume of the sound heard when a button is touched.

Setting item:

Key Sound

Setting contents:

0 to 6 (Initial setting: 3)

Auto Volume Setting

The volume of the sound heard is raised automatically according to the noise level by detecting engine noise and road noise.

Setting item:

Auto Volume

Setting contents:

Off (Initial setting) / Low / Middle / High

- The increasing rate of volume becomes large in this order: Low → Middle → High.

Setting Audio Mute On/Off while Backing up

The sound can be muted when the shift gear lever is set to the reverse (R) position enabling you to easily hear sensors, etc., while reversing your car.

Setting item:

Mute while backing up

Setting contents:

Off / On (Initial setting)

Off: Does not mute.

On: Mutes when the shift gear lever is set to the reverse (R) position.

Setting the Microphone Effect

Set this item when Apple CarPlay is used/Android smartphone which installed Android Auto App is connected.

You can turn on or off the Microphone Effect.

This setting influences Apple CarPlay/Android Auto mode.

Setting item:

Microphone EC / NR

Setting contents:

On (Initial setting) / Off

Default Sound Settings

You can restore the Dual HD EQ*/X-OVER*/Time Correction*/MX HD Level/Rear Speaker/Subwoofer/Subwoofer Level/Subwoofer Phase to factory settings.

Setting item:

Default Sound Settings

Touch **[Set]**, and the confirmation message appears.

To initialise, touch **[OK]**.

- * The setting values that are stored in Preset 1 to Preset 3 cannot be initialised.

About the Crossover

Crossover (X-OVER):

This unit is equipped with an active crossover. The crossover limits the frequencies delivered to the outputs. Each channel is controlled independently. Thus, each speaker pair can be driven by the frequencies for which they have been optimally designed.

The crossover adjusts the HPF (high pass filter) or LPF (low pass filter) of each band, and also the slope (how fast the filter rolls off the highs or lows).

Adjustments should be made according to the reproduction characteristics of the speakers. Depending on the speakers, a passive network may not be necessary. If you are unsure about this point, please consult your authorized Alpine dealer.

	Cut-off frequency (1/3 octave steps)		Slope		Level
	HPF	LPF	HPF	LPF	
Subwoofer (LPF)	----	20 Hz - 200 Hz	----	0, 6, 12, 18, 24 dB/oct.	0 to -12 dB
Rear speaker (HPF)	20 Hz - 200 Hz	----	0, 6, 12, 18, 24 dB/oct.	----	0 to -12 dB
Front speaker (HPF)	20 Hz - 200 Hz	----	0, 6, 12, 18, 24 dB/oct.	----	0 to -12 dB

Low range

High range

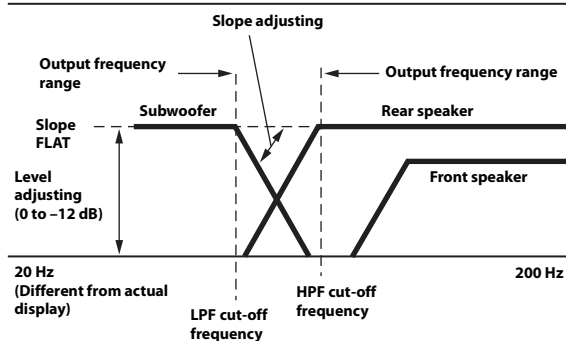

- **HPF (high pass filter):** Cuts the lower frequencies and allows the higher frequencies to pass.
- **LPF (low pass filter):** Cuts the higher frequencies and allows the lower frequencies to pass.
- **Slope:** The level change (in dB) for a frequency change of one octave.
- The higher the slope value, the steeper the slope becomes.
- Adjust the slope to FLAT to bypass the HP or LP filters.
- Do not use a tweeter without the HPF on or set to a low frequency, as it may cause damage to the speaker due to the low frequency content.
- Adjustment should be made according to the recommended crossover frequency of the connected speakers. Determining the recommended crossover frequency of the speakers. Adjusting to a frequency range outside that recommended may cause damage to the speakers. For the recommended crossover frequencies of Alpine speakers, refer to the respective Owner's Manual.

We are not responsible for damage or malfunction of speakers caused by using the crossover outside the recommended value.

About Time Correction

The distance between the listener and the speakers in a car vary widely due to the complex speaker placement. This difference in the distances from the speakers to the listener creates a shift in the sounds image and frequency characteristics. This is caused by the time delay between the sound reaching the listener's right versus the left ear.

To correct this, this unit is able to delay the audio signal to the speakers closest to the listener. This effectively creates a perception of increased distance for those speakers. The listener can be placed at an equal distance between the left and right speakers for optimum staging. The adjustment will be made for each speaker in 3.4 cm steps.

Example 1. Listening Position: Front Left Seat

Adjust the time correction level of the front left speaker to a high value and the rear right to zero or a low value.

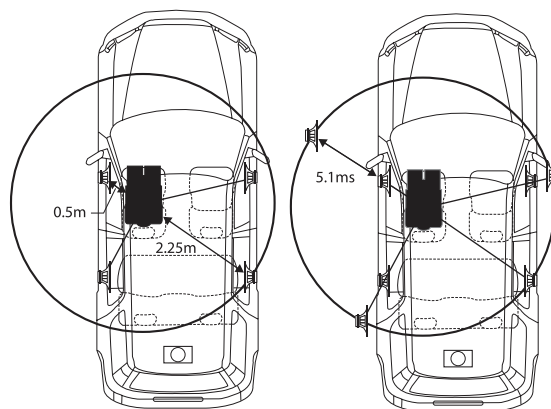

The sound is not balanced because the distance between the listening position and the various speakers is different.

The difference in distance between the front left speaker and the rear right speaker is 1.75 m (68-7/8").

Here we calculate the time correction value for the front left speaker in the diagram on the above.

Conditions:

Farthest Speaker – listening position : 2.25 m (88-9/16")

Front left speaker – listening position : 0.5 m (19-11/16")

Calculation: $L = 2.25 \text{ m} - 0.5 \text{ m} = 1.75 \text{ m}$ (68-7/8")

Time correction = $1.75 \div 343^* \times 1,000 = 5.1 \text{ (ms)}$

* Speed of sound: 343 m/s (765 mph) at 20°C

In other words, giving the front left speaker a time correction value of 5.1 ms makes it seem as if its distance from the listener is the same as the distance to the farthest speaker.

Time correction eliminates the differences in the time required for the sound to reach the listening position.

The time of the front left speaker is corrected by 5.1 ms so that its sound reaches the listening position at the same time as the sound of other speakers.

Example 2. Listening Position: All Seats

Adjust the time correction level of each speaker to almost the same level.

1 Sit in the listening position (driver's seat, etc.) and measure the distance (in meters) between your head and the various speakers.

2 Calculate the difference between the distance correction value to the farthest speaker and the other speakers.

$$L = (\text{distance to farthest speaker}) - (\text{distance to other speakers})$$

These values are the time correction values for the different speakers. Setting these values to make each sound reach the listening position at the same time as the sound of other speakers.

Time Correction Value List

Time Difference (msec)	Distance (cm)	Distance (inch)	Time Difference (msec)	Distance (cm)	Distance (inch)
0.0	0.0	0.0	5.1	173.4	68.3
0.1	3.4	1.3	5.2	176.8	69.7
0.2	6.8	2.7	5.3	180.2	71.0
0.3	10.2	4.0	5.4	183.6	72.4
0.4	13.6	5.4	5.5	187.0	73.7
0.5	17.0	6.7	5.6	190.4	75.0
0.6	20.4	8.0	5.7	193.8	76.4
0.7	23.8	9.4	5.8	197.2	77.7
0.8	27.2	10.7	5.9	200.6	79.1
0.9	30.6	12.1	6.0	204.0	80.4
1.0	34.0	13.4	6.1	207.4	81.7
1.1	37.4	14.7	6.2	210.8	83.1
1.2	40.8	16.1	6.3	214.2	84.4
1.3	44.2	17.4	6.4	217.6	85.8
1.4	47.6	18.8	6.5	221.0	87.1
1.5	51.0	20.1	6.6	224.4	88.4
1.6	54.4	21.4	6.7	227.8	89.8
1.7	57.8	22.8	6.8	231.2	91.1
1.8	61.2	24.1	6.9	234.6	92.5
1.9	64.6	25.5	7.0	238.0	93.8
2.0	68.0	26.8	7.1	241.4	95.1
2.1	71.4	28.1	7.2	244.8	96.5
2.2	74.8	29.5	7.3	248.2	97.8
2.3	78.2	30.8	7.4	251.6	99.2
2.4	81.6	32.2	7.5	255.0	100.5
2.5	85.0	33.5	7.6	258.4	101.8
2.6	88.4	34.8	7.7	261.8	103.2
2.7	91.8	36.2	7.8	265.2	104.5
2.8	95.2	37.5	7.9	268.6	105.9
2.9	98.6	38.9	8.0	272.0	107.2
3.0	102.0	40.2	8.1	275.4	108.5
3.1	105.4	41.5	8.2	278.8	109.9
3.2	108.8	42.9	8.3	282.2	111.2
3.3	112.2	44.2	8.4	285.6	112.6
3.4	115.6	45.6	8.5	289.0	113.9
3.5	119.0	46.9	8.6	292.4	115.2
3.6	122.4	48.2	8.7	295.8	116.6
3.7	125.8	49.6	8.8	299.2	117.9
3.8	129.2	50.9	8.9	302.6	119.3
3.9	132.6	52.3	9.0	306.0	120.6
4.0	136.0	53.6	9.1	309.4	121.9
4.1	139.4	54.9	9.2	312.8	123.3
4.2	142.8	56.3	9.3	316.2	124.6
4.3	146.2	57.6	9.4	319.6	126.0
4.4	149.6	59.0	9.5	323.0	127.3
4.5	153.0	60.3	9.6	326.4	128.6
4.6	156.4	61.6	9.7	329.8	130.0
4.7	159.8	63.0	9.8	333.2	131.3
4.8	163.2	64.3	9.9	336.6	132.7
4.9	166.6	65.7			
5.0	170.0	67.0			

Visual Setup

[Visual] is selected on the General Setup Menu screen in step 1. See "General Setup" (page 30).

You can set up items related to an image.



Settable items differ depending on the application.

[Video] (Video media)*1:

Visual EQ / Brightness / Colour / Tint / Contrast / Sharpness

[Camera]*2:

Brightness / Colour / Contrast

[Navigation] (X902D/X802D-U/INE-W710D only):

Brightness / Contrast

*1 "Video" can be selected while a video is playing.

*2 The camera names are not displayed when "Off" is set (page 44).

Selecting the Visual EQ Mode (Factory's setting)

You can select a mode suitable for the subject image.

Setting item:

Visual EQ

Setting contents:

Off (Initial setting) / Night / Soft / Sharp / Contrast

Off: Initial Setting

Night: Suitable for movies in which dark scenes frequently appear.

Soft: Suitable for CGs and animated films.

Sharp: Suitable for old movies where images are not clearly shown.

Contrast: Suitable for recent movies.

- To return to the default video settings, set this function to Off. Any Visual EQ selection or changes made are reset their initial settings.

Adjusting Brightness

Setting item:

Brightness

Setting content:

-15 to +15 (Initial setting: 0)

You can adjust the brightness between MIN (-15) and MAX (+15). When it reaches the minimum or maximum point, the display shows "MIN" or "MAX" respectively.

Adjusting Colour of Picture

Setting item:

Colour

Setting content:

-15 to +15 (Initial setting: 0)

You can adjust the colour between MIN (-15) and MAX (+15). When it reaches the minimum or maximum point, the display shows "MIN" or "MAX" respectively.

Adjusting Tint of Picture

Setting item:

Tint

Setting content:

R15 to G15 (Initial setting: 0)

Adjust the Colour from R15 to G15.

Adjusting Image Contrast

Setting item:

Contrast

Setting content:

-15 to +15 (Initial setting: 0)

You can adjust the contrast between MIN (-15) and MAX (+15). When it reaches the minimum or maximum point, the display shows "MIN" or "MAX" respectively.

Adjusting Picture Quality

Setting item:

Sharpness

Setting content:

-5 to +5 (Initial setting: 0)

Picture quality adjustment range is -5 to +5. "SOFT" and "HARD" appear as the minimum and maximum values specified.

Saving and calling the adjusted picture quality

When adjusting audio (video media), you can store the settings made for "Adjusting Brightness, Colour, Tint, Contrast and Sharpness."

Setting item:

Preset 1 / Preset 2

1 After completing "Adjusting Brightness, Colour, Tint, Contrast and Sharpness" (page 37), touch and hold [Preset 1] or [Preset 2] to save the settings.

2 Touch [Preset 1] or [Preset 2] to call the saved settings.

Screen Setup

[Screen] is selected on the General Setup Menu screen in step 2. See "General Setup" (page 30).

You can set up the brightness, colour, display, etc., of the screen.

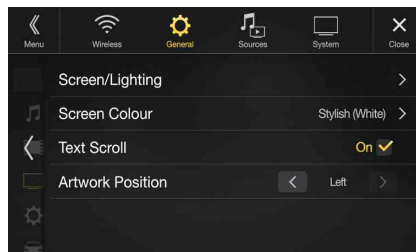

Screen/Lighting Customise

1 Touch [Screen/Lighting] in the Display/Key Setup Menu screen.

The Screen/Lighting setup screen appears.

Setting item:

Dimmer / Key Illumination Level / Screen Dimmer Level

Setting the Brightness of the Backlighting

Backlighting is provided by LEDs light built into the liquid crystal panel. The illumination control adjusts the brightness of the backlighting based on the car ambient lighting for easier viewing.

Setting item:

Dimmer

Setting contents:

Auto (Initial setting) / On / Off

Auto: Adjust the brightness of the background illumination of the monitor automatically to the brightness of the car interior.

On: Keep the background illumination of the monitor dark.

Off: Deactivate Auto Dimmer mode to keep the background illumination of the monitor bright.

- When "On" is set, the setting is also applied for the button lighting in "Adjusting the Dimmer of Button Lighting at Night" (page 37), and "Adjusting the Minimum Level of Backlight" (page 38).

Adjusting the Dimmer of Button Lighting at Night

You can adjust the brightness of the button lighting at night with the dimmer.

Setting item:

Key Illumination Level

Setting level:

-2 to +2 (Initial setting: 0)

- This setting is only available when "Dimmer" is set to "On."

Adjusting the Minimum Level of Backlight

You can adjust the brightness of the backlight. This function could be used, for instance, to change the screen brightness while travelling at night.

Setting item:

Screen Dimmer Level

Setting content:

-15 to +15 (Initial setting: 0)

You can adjust the level between MIN (-15) and MAX (+15). When it reaches the minimum or maximum point, the display shows "MIN" or "MAX" respectively.

- This setting is only available when "Dimmer" is set to "On" or "Auto."

Switching the Display Colour

You can choose from 8 different display colours.

Setting item:

Screen Colour

Setting contents:

Sporty (Blue) / Sporty (Red) / Stylish (White) / Stylish (Red) / Blue / Light Blue / Green / Amber

- The initial setting for X902D is "Stylish (White)", for X802D-U/INE-W710D is "Blue".

Switching the Illumination Colour (X802D-U/INE-W710D/iLX-702D only)

You can choose the colour of the Front Panel button from one of 7 colours.

Setting item:

Illumination Colour

Setting contents:

Blue (Initial setting) / Light blue / Aqua blue / Red / Green / Amber / Yellow

Setting the Text Scroll

Scroll display is available if folder name, file name or tag information is entered.

Setting item:

Text Scroll

Setting contents:

Off / On (Initial setting)

- Off: Turns off the scroll mode.
On: Turns on the Auto scroll mode. Scroll display is repeated as long as the mode is turned on.

Switching the Artwork Position

You can set the artwork position to the centre or the left.

Setting item:

Artwork Position

Setting contents:

Centre / Left (Initial setting)

General Setup

[General] is selected on the General Setup Menu screen in step 1. See "General Setup" (page 30).

You can set up items related to the language, etc.

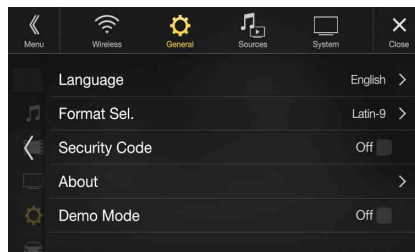

Setting the Menu Language

The Setup menu, feedback information, etc. for this unit can be changed to appear in the selected language.

Setting item:

Language

Setting contents:

English / Deutsch / Français / Español /
Português / Italiano / Nederlands / Suomi /
Norsk / Svenska / Dansk / русский язык /
Slovenčina / Polski / Český / Magyar / Ελληνικά /
עברית / العربية / Türkçe / 中文 /
Bahasa Indonesia

Format settings

The character code to be used for tag text information displayed on the screen can be selected from 7 character codes.

Setting item:

Format Sel.

Setting contents:

Latin-1 / Latin-9 (Initial setting) / Russian / Chinese / Thai / Arabic / Hebrew

Latin-1:	ISO 8859-1
Latin-9:	ISO 8859-15
Russian:	ISO 8859-5
Chinese:	GB18030-2005
Thai:	CP874
Arabic:	CP1256
Hebrew:	CP1255

Setting the Clock Display (i902D/iLX-702D only)

You can select the clock display type, 12-hour or 24-hour, depending on your preference.

Setting item:

Clock Mode

Setting contents:

12h (Initial setting) / 24h

Setting the Time (i902D/ iLX-702D only)

Setting item:

Time Adjust

Additional items:

Hour / Minute

Setting content:

AM12 - PM12 or 0-23 / 0-59

Hour: Adjust the hour.

Minute: Adjust the minute.

- Cannot be adjusted while no GPS signal is received.

Setting Security code

You can set the system to be unusable without entering a password. When you turn this setting to “On” and set a password, password input is required when the system is connected to a battery and turned on for the first time.

Setting item:

Security Code

Setting contents:

Off (Initial setting) / On

Setting the password

1 Touch the checkbox “Off” () of the Security Code.

2 After the confirmation message appears, touch [OK].

The password setting screen is displayed.

3 Enter a password, then touch [OK].

- Enter the 6-digit number.
- Input numbers are displayed as “*”.
- Touch [] to delete an entered number.

4 Enter the same password again, then touch [OK].

The password is set and the system returns to the General Setup Menu screen, then the checkbox of the Security Code is set to “On” ()

- If you forget a registered password, you can not use this unit. In this case, service will be required.

Clearing the password

1 Touch the checkbox “On” () of the Security Code.

The password setting screen is displayed.

2 Enter the password you have set, then touch [OK].

The password is cleared and the system returns to the General Setup Menu screen, then the checkbox of the Security Code is set to “Off” ()

- Input numbers are displayed as “*”.

About X902D/X802D-U/INE-W710D/i902D/ iLX-702D

[About] enables you to check the Serial Number, Firmware Version, Model Name, and to initialise various settings.

Displaying the Product Information

You can view the version information of this product. Make note of this information and refer to it whenever you contact Alpine Tech Support or an Alpine-authorized dealer.

Setting contents:

Serial Number / Firmware Version / Model Name

Initializing the System

You can initialise all data, to restore the factory settings. Remove the USB flash drive, etc. from the system before operation

Setting item:

Clear All Settings

1 Touch [Reset] of “Clear All Settings.”

2 After the confirmation message appears, touch [OK].

The confirmation screen appears again.

3 Touch [OK].

The system starts initialisation.

- Do not turn on/off the power, change the ignition key position or remove the screen panel until system restart is completed.

Setting Demo mode to Off/On

This unit has a Demonstration feature for the display. When you install and use the unit for the first time, the unit will enter demo mode automatically. To quit demo mode, set Demo mode to Off.

Setting item:

Demo mode

Setting contents:

Off / On (Initial setting)

- If you perform an operation during the Demo mode, the demonstration is temporarily stopped.

Car Setup

[Car] is selected on the General Setup Menu screen in step 1. See “General Setup” (page 30).

Steering wheel Setting

Set this item when Apple CarPlay is used/Android smartphone which installed Android Auto App is connected.

This setting influences Apple CarPlay/Android Auto mode.

Setting item:

Steering wheel

Setting contents:

Left (Initial setting) / Right

Installation Setup

Vehicle Setup enables you to check the connection status of Reverse Lead/Parking Brake Lead.

Setting item:

Installation Status

The Installation check screen is displayed.

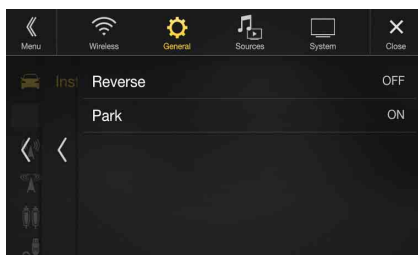

Sources Setup

[Sources] is selected on the Setup main screen in step 3. See “Setup Operation” (page 27).

Sources Setup Menu screen

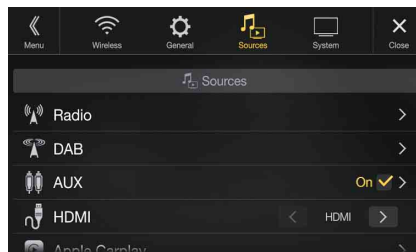

<Setting items>

Radio
PI Seek
RDS Regional
PTY Language
PTY31
FM Tuner Setting
DAB
Alarm
Announcement Mode
FM Linking
DAB Antenna Power
AUX*1
AUX Name*2
Direct Touch*2
Signal*2
HDMI*3
Apple CarPlay*4

*1 This setting cannot be changed while the AUX source is being selected.

*2 This setting is only available when “AUX” is set to “On” (☑).

*3 This setting cannot be changed while the HDMI source is being selected.

*4 This setting cannot be adjusted when an iPod/iPhone is connected or Apple CarPlay/iPod source is being selected.

The following steps 1 to 3 are common to each “Setting item” of Audio Setup. See each section for details.

- 1 Select the desired item.**
- 2 To switch the setting, touch [⟨], [⟩], [+], [–], or mark the checkboxes “Off” (☐) or “On” (☑).**
 - If “>” appears, there is a further hierarchy. Touch the desired item.
- 3 Touch [X] to return to the main source screen.**
 - To return to the previous List screen, touch [⟨⟨] or [⟨] in the previous page. For details, see “About Basic Operation for List Screen” (page 17).

Radio Setup

[Radio] is selected on the Sources Setup Menu screen in step 1. See “Sources Setup” (page 40). You can set up the items related to the radio reception sensitivity, etc.

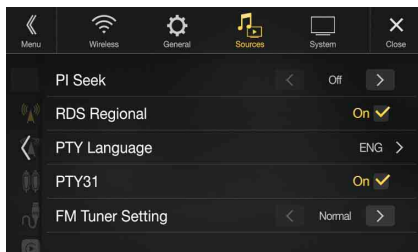

PI SEEK Setting

Setting item:

PI Seek

Setting contents:

Auto / Off (Initial setting)

Receiving RDS Regional (Local) Stations

When Off is selected, the unit automatically keeps receiving the local RDS station.

Setting item:

RDS Regional

Setting contents:

On (Initial setting) / Off

Switching the Display Language of PTY (Programme Type)

Setting item:

PTY Language

Setting contents:

ENG (Initial setting) / GER / FRE / SPA / POR / ITA / DUT / DAN / FIN / NOR / SWE / RUS

ENG:	English
GER:	German
FRE:	French
SPA:	Spanish
POR:	Portuguese
ITA:	Italian
DUT:	Dutch
DAN:	Danish
FIN:	Finnish
NOR:	Norwegian
SWE:	Swedish
RUS:	Russian

Setting PTY31 (Emergency Broadcast) Reception

PTY31 (Emergency Broadcast) reception can be set to On/Off.

Setting item:

PTY31

Setting contents:

On (Initial setting) / Off

- The unit automatically gives priority to an emergency broadcast whenever it begins, and interrupts the programme you are currently listening to when PTY31 is set to “On”.
- The unit will show “Alarm” in the display during PTY31 reception.
- This setting works with the Alarm (Emergency Broadcast) of DAB.

Setting the TUNER (FM) Tone Quality (Tuner Condition)

This unit can set your preferred tone quality for FM radio source.

Setting item:

FM Tuner Setting

Setting contents:

Normal (Initial setting) / HiFi / Stable

Normal:	Standard setting
HiFi:	High-quality setting
Stable:	Control noise

- Noise may be more noticeable when HiFi is set, depending on the reception status. In this case, the Normal setting is recommended.

DAB Setting

[DAB] is selected on the Sources setup menu in step 1. Refer to “Sources Setup” (page 40).



Setting Alarm (Emergency Broadcast) Reception

Turn Alarm (Emergency Broadcast) reception On/Off.

Setting item:

Alarm

Setting contents:

Off / On (Initial setting)

- Off: Emergency Broadcasts will not be received.
On: Emergency broadcasts are received regardless of source.

- This setting works with PTY31 (Emergency Broadcast) of RDS.
- When an emergency broadcast is received, the volume level will be automatically changed to the memorised level in the traffic information mode. For details, see “Receiving Traffic Announcement” (page 56).

Setting Announcement Reception

You can select your desired station from 8 announcement types. If “On” is set, when the selected announcement is received, the unit will switch to the DAB source screen automatically and will receive the broadcast.

Setting item:

Announcement Mode → Transport News / Warning/Service / Area Weather News / Event Announcement / Special Event / Program Information / Sport News / Financial News

Setting contents:

Off (Initial setting) / On

Setting the FM Linking ON/OFF (Service Following)

This unit provides FM Linking function which can switch the source from DAB+/DMB to FM radio when the digital signal is weak.

Setting item:

FM Linking

Setting contents:

Off / On (Initial setting)

- Off: Keep receiving the digital signal, even when the digital signal is weak.
On: If the digital signal is weak, this unit will switch to receive the analogue FM radio signal automatically. When receiving an analogue FM radio signal, the “FM Linking” indicator is displayed.

Setting the DAB Antenna ON/OFF

You can choose whether to supply power to DAB Antenna Connector by this setting. Confirm the type of DAB Antenna (sold separately) before installing the DAB antenna. If an active antenna that needs power supply from this unit is used, set DAB Antenna Power to On; if a passive antenna that does not need power supply from this unit is used, make sure to set DAB Antenna Power to Off, otherwise, a malfunction may occur.

Setting item:

DAB Antenna Power

Setting contents:

Off (Initial setting) / On

- Off: When no DAB Antenna is connected or the connected DAB Antenna does not need power supply from this unit.
On: When the connected DAB Antenna needs power supply from this unit.

- If the “DAB Antenna error.” message is displayed on the unit, this setting becomes invalid. For details on what to do if “DAB Antenna error,” is displayed, see “If this Message Appears” (page 90).

AUX Setup

[AUX] is selected on the Sources Setup Menu screen in step 1. See “Sources Setup” (page 40).
You can set up the items related to the Auxiliary device.

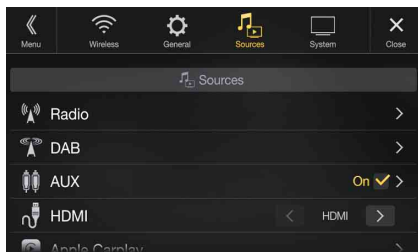

Setting item:

AUX

Setting contents:

Off / On (Initial setting)

- Off: AUX source is not displayed.
- On: AUX source is displayed.

■ Usable 4-pole mini AV plug

The unit accepts the following 4-pole mini AV plug pin-out:

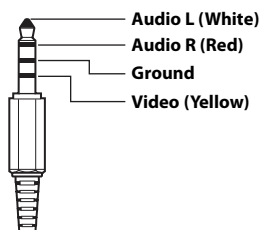

- Please check pin-out carefully before use of this product. Depending on the cable, there may be no picture and/or sound.

Setting the Auxiliary (AUX) Name

Make sure the AUX is set to “On” (☑). See “AUX Setup” (page 43).

Setting item:

AUX Name

Setting contents:

AUX (Initial setting) / AUX DVD / GAME / External DVD / DVD Changer / DVB-T / TV / USB Player

Setting Direct Touch Operation

If DVB-T is set as the AUX Name, this setting is available.

Setting item:

Direct Touch

Setting contents:

On (Initial setting) / Off

- On: Direct Touch operation is available on the DVB-T screen.
- Off: Direct Touch operation is not available on the DVB-T screen.

Switching the Visual Input Signal System

You can make this setting only when AUX is set to “On” (☑). See “AUX Setup” (page 43).

Setting item:

Signal

Setting contents:

Auto (Initial setting) / NTSC/PAL

- Auto: The video input signal type (NTSC or PAL) will be automatically selected.
- NTSC/PAL: Choose the video input signal type manually.

HDMI Setup

[HDMI] is selected on the Sources Setup Menu screen in step 1. See “Sources Setup” (page 40).

You can set the name of an external device connected via HDMI.

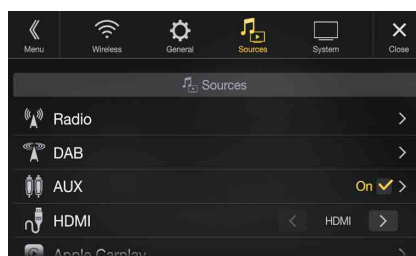

Setting item:

HDMI

Setting contents:

HDMI (Initial setting) / DVD

- HDMI: Set when a smartphone is connected via HDMI.
- DVD: Set when an external DVD player is connected.

Apple CarPlay Setup

[Apple CarPlay] is selected on the Sources Setup Menu in step 1. See “Sources Setup” (page 40).

Before connecting an iPhone 5 or later, turn on this item to use the Apple CarPlay function.

Setting item:

Apple CarPlay

Setting contents:

On (Initial setting) / Off

- On: Set before an iPhone 5 or later is connected, the Apple CarPlay can be used, but the iPod source, iHeartRadio and Spotify of Alpine Connect are not available at this time. Alpine Tunelt App is not available normally also.
- Off: Set when you want to use the iPod source, etc., of the connected iPhone 5 or later.

- This setting is invalid for music playing of iPhone 4S and iPod.

System Setup

[System] is selected on the Setup main screen in step 3. See “Setup Operation” (page 27).

■ System Setup Menu screen

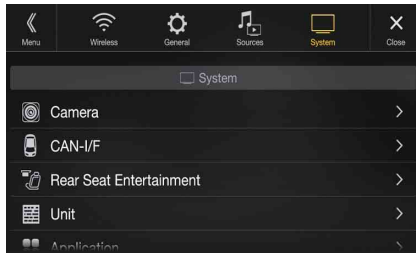

<Setting items>

Camera*1	Camera Select
	Camera Signal*2
	Guide Adjustment*3
	Interrupt (Power OFF)*4
CAN-I/F	Default Vehicle Screen
	Climate screen interrupt time
	Parking sensor interrupt
Rear Seat Entertainment	Rear Seat Entertainment
	Remote Sensor
Unit	External AP
	HDMI selector
Application	Connectivity Setting*5 (X902D/X802D-U/INE-W710D only)
	Alpine TuneIt App*6
	Alpine Connect*7 (X902D/X802D-U/INE-W710D only)

*1 When you select “Camera Selector” in “Camera Select”, the setting item is different. For details, see “Setting Multi Camera to On/Off” (page 46).

*2 When Camera Select is set to “Off”, you cannot select this item.

*3 You can select this item only when Camera Select is “Front” or “Rear.”

*4 You can select this item only when Camera Select is “Rear.”

*5 Set this setting after closing the Alpine TuneIt App and Alpine Connect App.

*6 Set this setting after closing the Alpine TuneIt App.

*7 Set this setting after closing the Alpine Connect App.

The following steps 1 to 3 are common to each “Setting item” of System Setup. See each section for details.

1 Select the desired item.

2 To switch the setting, touch [<], [>], [+], [-], or mark the checkboxes “Off” () or “On” ().

- If “>” appears, there is a further hierarchy. Touch the desired item.

3 Touch [X] to return to the main source screen.

- To return to the previous List screen, touch [<<] or [<] in the previous page. For details, see “About Basic Operation for List Screen” (page 17).

Camera Setup

[Camera] is selected on the System Setup Menu screen in step 1. See “System Setup” (page 44).

You can set up items related to the Camera.



Setting the Camera Input

Setting item:

Camera Select

Setting contents:

Off (Initial setting) / Front / Rear / Other / Camera Selector

Front: Front camera

Rear: Rear camera

Other: Side camera, Room camera, etc.

Camera Selector*: Front Camera/Rear Camera/Side Camera connected to the optional Multi Camera Interface module.

* When selecting Camera Selector, you can set the Front Camera/Rear Camera/Side Camera to On/Off. For details, see “Setting Multi Camera to On/Off” (page 46).

Setting the Camera Signal Input

When the camera is connected, the video input signal type can be chosen.

Further setting item:

Camera Signal

Setting contents:

NTSC (Initial setting) / PAL

Switching Video Patterns for Multi View Camera

The video pattern can be changed when connected to Multi View Camera.

When Camera Select is set to “Off” or “Other,” you cannot select this item.

Setting item:

Guide Adjustment

1 Touch [Guide Adjustment].

The camera guide adjustment screen is displayed.

Multi View compatible Side Camera

2 Touch [Front] or [Rear].

The view will change to the selected view.

Multi View compatible Front Camera/Rear Camera

2 Touch [Back], [Panorama], [Corner], or [Top].

The view will change to the selected view.

- [Back] will not appear for the Front camera.
- For an explanation of video patterns, see the camera Owner's Manual.

Adjusting the Rear/Front/Side Camera Guide

You can adjust the camera guide position.

Setting item:

Guide Adjustment

1 Touch [Guide Adjustment].

The camera guide adjustment screen is displayed.

- If the video pattern is set to "Corner (Rear/Front Camera only)," the camera guide will not be displayed.
- When you connect a Multi View compatible camera, select a Video Pattern to make a guide adjustment.
- When you connect a Multi View compatible Side Camera, after selecting the Video Pattern, touch [Left steering] or [Right steering] (Right steering) to make the guide adjustment that matches the position of the steering wheel in your vehicle.

2 Touch [Adjust].

- If [Adjust] does not appear, proceed to step 3.

3 Touch the guide you intend to adjust.

Guide line can also be selected by touching [▼] [▲].

Rear Camera screen example

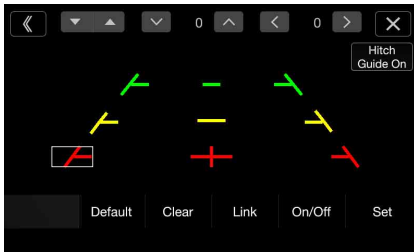

- You cannot adjust the position of the yellow guide line "—" in the centre independently. It is controlled by a system to be the centre of the two yellow guide lines "↘" and "↙" on the left and right, or the central green line "—" and red guide line "⊕".

Front Camera screen example

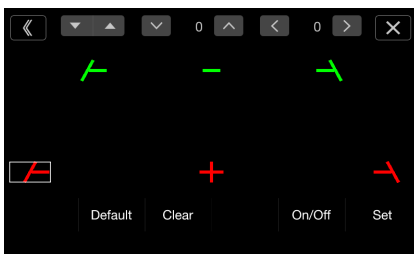

Side Camera screen example

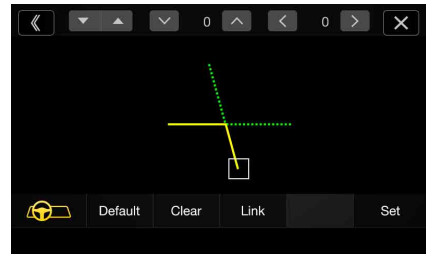

4 Touch [▼], [▲], [←] or [→] to adjust the position of the guide.

- Touching [Clear] clears adjustments and returns to the setting before guide line alteration.

5 After the adjustment is completed, touch [Set].

Adjusting Guides Simultaneously (for Rear/Side Camera only)

<Rear Camera>

1 Touch [Link].

The 3 vertical guides of the currently-selected guide link together, allowing them to be adjusted simultaneously.

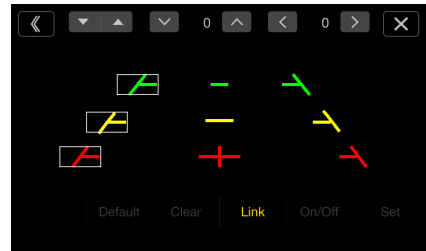

- Note on the yellow guide line "—" in the centre
The yellow guide line "—" in the centre is controlled by a system that locates it in the centre of the two yellow guide lines, "↘" and "↙" on the left and right, or the green line "—" on the top and red guide line "⊕" below. Therefore you cannot move it manually.

<Side Camera>

1 Touch [Link].

The 2 vertical guides of the currently-selected guide link together, allowing them to be adjusted simultaneously.

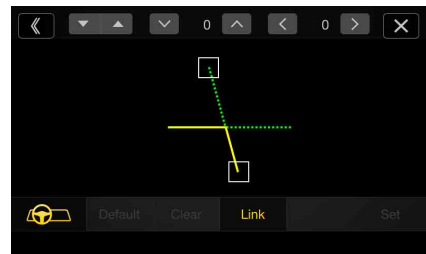

Turning Guide Display On/Off (Rear/Front Camera only)

Turning the selected guide off.

1 Touch [On/Off].

The currently selected guide will turn off.

2 To turn the guide on, touch [On/Off] again.

- Guides that are turned off are still adjustable.

Returning Guides to Default

1 Touch [Default].

A message window will appear.

2 Touch [OK].

Adjusted values will return to default settings.

Camera Interrupt Setting (Power OFF Mode) (Rear Camera Only)

You can set whether to display the rear camera image when the gear lever is moved to the reverse (R) position while the unit is turned off. You can select this item only when Camera Select is "Rear."

Setting item:

Interrupt (Power OFF)

Setting contents:

On (Initial setting) / Off

- On: The rear camera image is displayed
Off: The rear camera image is not displayed

Setting Multi Camera to On/Off

When connecting the optional Multi Camera Interface module, you can connect up to 3 cameras as Front Camera/Rear Camera/Side Camera.

- When using the optional Multi Camera Interface module, select "Camera Selector" to set the "Front Camera /Rear Camera/Side Camera" to "On" (☑) / "Off" (☐).



Setting item:

Front Camera / Rear Camera / Side Camera / Default Camera*

Setting contents:

Off (Initial setting) / On

- Camera: See "Setting the Camera Input" (page 44)
Signal:
Guide: See "Adjusting the Rear/Front/Side Camera Guide" Adjustment: (page 45)
Camera: See "Camera Interrupt Setting (Power OFF Mode) (Rear Interrupt Camera Only)" (page 46)
(Power Mode):

* You can change the Default Camera only when you set more than one camera for Front Camera/Rear Camera/Side Camera to "On." For details, see "Setting a Default Camera" (page 46).

Setting a Default Camera

When connecting an optional Multi View Camera, you can set which camera image is displayed when you touch the Camera button on the Menu screen.

Setting item:

Default Camera

Setting contents:

Front / Rear / Side

- The initial setting differs depending on the cameras set to "On" in "Setting Multi Camera to On/Off."

CAN-I/F Setup

[CAN-I/F] is selected on the System Setup Menu screen in step 1. See "System Setup" (page 44).



- CAN I/F BOX should be connected before this operation.

Setting the Default Vehicle Screen

Touch the Menu screen (page 19) to display the Info mode screen, and then set the following.

Setting item:

Default Vehicle Screen

Setting contents:

Climate / Park sensor / Last mode (Initial setting)

- For details on the Vehicle Info mode screen, see "About Vehicle Interlock Function" (page 86).

Setting the Climate Interrupt Time

You can set the time displayed in the Climate screen.

Setting item:

Climate screen interrupt time

Setting contents:

None / 5 sec (Initial setting) / 10 sec / Continuous display

- None: The Climate screen is not displayed when you adjust the air conditioner, etc.
5 sec/10 sec*: The screen is displayed for 5 seconds/10 seconds, then returns to the previous screen.
Continuous display: The Climate screen is continuously displayed.

* If you set the air conditioner, etc., while the Climate screen is displayed, the screen will continuously be displayed.

- For details, see "About Vehicle Interlock Function" (page 86).

Setting the Parking Sensor Interrupt On/Off

Set to "On" to display the Parking Assist screen if a vehicle detects an obstacle.

Setting item:

Parking sensor interrupt

Setting contents:

Off / On (Initial setting)

- For details, see "About Vehicle Interlock Function" (page 86).

Rear Seat Entertainment Setup

[Rear Seat Entertainment] is selected on the System Setup Menu screen in step 1. See "System Setup" (page 44).

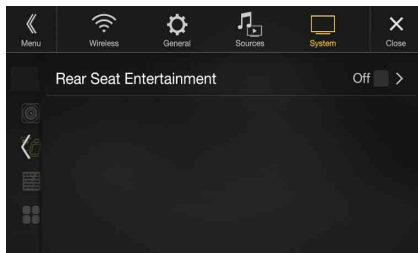

When a Rear monitor equipped with HDMI input is connected to this unit, change this setting to "On." You can output images to the Rear monitor. For details, see "Rear Seat Entertainment Function" (page 18).

Setting item:

Rear Seat Entertainment

Setting contents:

Off (Initial setting) / On

- When this setting is "On," you can use this unit to switch the Illumination of a Rear monitor with the Illumination function.

Setting the Rear Seat Entertainment System

Make sure the Rear Seat Entertainment is set to "On" (☑). See "Rear Seat Entertainment Setup" (page 47).

Setting item:

Illumination Colour

Setting contents:

Off (Initial setting) / On

- For details on adjusting Illumination, see "Rear Seat Entertainment Function" (page 18).
- When the Rear Seat Entertainment setting is set to "Off," you cannot select this item.
- Set the coordination colour controls on the Rear monitor to "Navi." When set to "Rear monitor," you cannot operate them from this unit.

Remote Sensor Setting

Make sure the Rear Seat Entertainment is set to "On" (☑). See "Rear Seat Entertainment Setup" (page 47).

For remote control operation, the remote sensor of the external device (Rear monitor, etc.) can be switched, as you prefer.

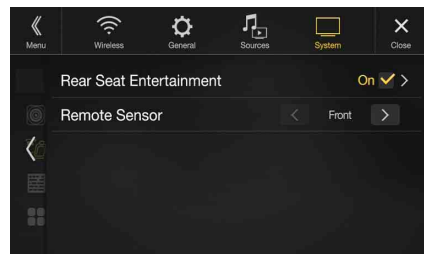

Setting item:

Remote Sensor

Setting contents:

Front (Initial setting) / Rear

- Front: The remote sensor of this unit is effective.
Rear: The remote sensor of Rear monitor is effective.

- You can also control this setting from the Rear Seat Entertainment System Setup screen. For details, see "Rear Seat Entertainment Function" (page 18).

Unit Setup

[Unit] is selected on the System Setup Menu screen in step 1. See "System Setup" (page 44).

Make this setting when you use an external audio processor.

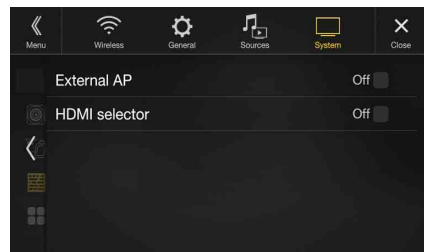

Setting the External AP

When using an external audio processor, set to "On" (☑).

Setting item:

External AP

Setting contents:

Off (Initial setting) / On

- When this setting is "On," the Volume level is fixed at 10. Also, Balance/Fader/Subwoofer Level/Subwoofer Phase/Bass/Treble/MX HD/EQ Presets/Dual HD EQ/X-OVER/Time Correction/Defeat/Phone Speaker/Default Sound Settings are set to "Off" or "Flat" and cannot be adjusted.
- Use the external AP to adjust volume.

Setting the HDMI Selector On/Off

If you connect an HDMI selector, you can connect two HDMI devices. When using an HDMI selector, set to “On” (☑).

Setting item:

HDMI selector

Setting contents:

Off / On (Initial setting)

- For details on switching the HDMI source when two HDMI devices are connected, see “HDMI Operation” (page 70).

Application Setup

[Application] is selected on the System Setup Menu screen in step 1. See “System Setup” (page 44).



Set Alpine Tunelt App and Alpine Connect App to USB (iPhone) when an iPhone is connected, or set to Bluetooth (Android) when an Android Smartphone is paired.

Setting item:

Connectivity Setting*1 / Alpine Tunelt App*2 / Alpine Connect*3

Setting contents:

Off / USB (iPhone) (Initial setting) / Bluetooth (Android)*4

- Off: No Smartphone is connected.
- USB (iPhone): When an iPhone is connected to the unit's USB port, you can programme the unit's sound tuning parameters, or communicate with SNS.
- Bluetooth (Android): Set this when an Android Smartphone is paired with this unit via Bluetooth technology. And after Bluetooth Audio is connected, you can programme the unit's sound tuning parameters, or communicate with SNS.

- Set this setting after closing the Alpine Tunelt App and Alpine Connect App.
- For this function to work properly, specific applications must be installed on your Smartphone before connection. Consult your Alpine dealer or the Alpine website for details.
- Only the iPhone and certain Android Smartphones support this function.

*1 Select “Connectivity Setting” to set the connection procedure for the “Alpine Tunelt App” and “Alpine Connect” to the same setting. (X902D/X802D-U/INE-W710D only)

*2 Set this setting after closing the Alpine Tunelt App.

*3 Set this setting after closing the Alpine Connect App. (X902D/X802D-U/INE-W710D only)

*4 Not displayed when Bluetooth is set to Off. For details, see “Bluetooth Setup” (page 28).

Android Auto (Optional)

What is Android Auto

Android Auto is designed to make it easier to use apps from your phone while you're on the road. Navigate with Google Maps, listen to playlists or podcasts from your favourite apps, and more.

Activate Android Auto

Download the Android Auto App from the Google Play store before continuing.

Just plug in your smartphone to the unit's USB connector, then follow the prompt to pair your smartphone with the unit.

- The connected smartphone with Android Auto will disconnect other phone's Bluetooth connection and pair to the unit.

1 Press the MENU button.

The Menu screen is displayed.

2 Touch [Android Auto].

The Android Auto screen is displayed.

- When a used smartphone is reconnected, touch the pop-up message-“Android Auto connected” within 5 seconds to access to Android Auto screen, or you can ignore prompt by touching [X] on the top right.
- You can make a call, use voice recognition function and Android Auto's compatible navigation app, etc.,
- Only Google approved apps with necessary driver-safety measures in place can be used.

Apple CarPlay (Optional)

Apple CarPlay is a smarter, safer way to use your iPhone in the car. Apple CarPlay takes the things you want to do with your iPhone while driving and puts them right on the unit. You can get directions, make calls, send and receive messages, and listen to music, all in a way that allows you to stay focused on the road. Just plug in your iPhone to the unit and go.

- Before using this function, turn *Apple CarPlay to On* (page 43) and plug in your iPhone using *Lightning to USB Cable (Supplied with iPhone)* to the unit.
- Some functions may not be available while driving.
- About iPhone models usable with this unit, see “*iPod/iPhone (Optional)*” (page 61). Only an iPhone 5 or later compatible with Apple CarPlay function.

Access to Apple CarPlay

1 Press the MENU button.

The Menu screen is displayed.

2 Touch [Apple CarPlay].

The Apple CarPlay mode is activated.

Touch the desired App icon on the unit, or use Siri function by pressing  or VOICE button.

- When a used iPhone 5 or later is reconnected, touch the pop-up message-“Apple CarPlay connected.” within 5 seconds to access to Apple CarPlay screen, or you can ignore prompt by touching [X] on the top right.
- The App must be Apple CarPlay compatible in order to appear in the Home screen.

Alpine Connect App (Optional) (X902D/ X802D-U/INE-W710D only)

Activate Alpine Connect App

Download an app that supports Alpine Connect to your smartphone, and you can operate it from the unit.

Alpine Connect App is downloadable from Apple’s App Store; the Android user can download it from Google Play. For details, consult your Alpine dealer.

Before these operations, set Connectivity Setting or Alpine Connect to USB (iPhone) or Bluetooth (Android) depending on the connected Smartphone. For details, see “Application Setup” (page 48).

1 Launch Alpine Connect App.

2 Then connect the smartphone to this unit.

3 Press the MENU button.

The Menu screen is displayed.



4 Touch [Alpine Connect].

The Alpine Connect App select screen is displayed.

5 Select the desired App.

The selected App screen is displayed.

- Before an iPhone 5 or later is connected, turn *Apple CarPlay to Off*, then enjoy *iHeartRadio*. (page 43)

Radio/RDS

■ RDS (FM1/FM2) main screen example



Function mode

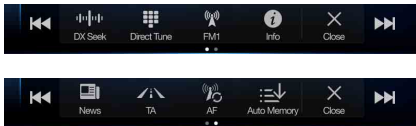

- ① Source Title/Band display
Displays the band of the signal currently being received.
- ② RDS indicator
- ③ Info area
Station Info. Mode: PTY / Frequency or PS / Artist Name / Song Name / Album Name
Radio Text Mode: Frequency / Radio Text
 - For details on switching the display of the Radio text, see "Displaying Radio Text" (page 53).
- ④ Preset mode button
Touch or swipe to the right when you use the Preset mode screen.

■ Preset mode screen example



- ⑤ Preset button
Swipe vertically in the list to change pages.
- ⑥ PTY list button
Swipe to the right when you use the PTY list screen.

■ MW/LW band main screen example

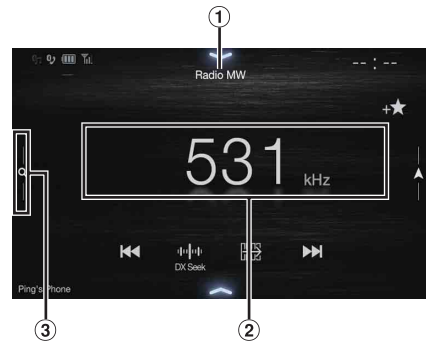

Function mode

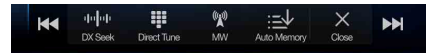

- ① Band display
Displays the band of the signal currently being received.
- ② Frequency display
- ③ Preset mode button
Touch or swipe to the right when you use the Preset mode screen.

■ Preset mode screen example



- ④ Preset button
Swipe vertically in the list to change pages.

Radio Basic Operation

Listening to the Radio

- 1 Press the (AUDIO) button to select radio mode.**
The display shows the radio mode screen.
 - You can select and change the source from the Menu screen (page 19) or the Favourite screen (page 22).
- 2 Touch .**
The radio band select pop up screen is displayed.
 - button displays the current selected band. (e.g. [FM1])
- 3 Select the desired band from FM1/FM2/MW/LW.**
- 4 Touch .**
The tuning mode selection popup is displayed.
 - button displays the current selected mode. (e.g. [DX Seek])
- 5 Touch the desired tuning mode.**
The radio frequency up or down button changes depending on the tuning mode.

DX Seek	Local Seek	Manual
PTY	Preset	

 - There are two modes you can select for auto tuning, DX and Local:
 - DX Seek (Distance) mode;
Both strong and weak stations will be tuned in.
 - Local Seek mode;
Only strong stations will be tuned in.
The initial setting is DX.
 - Manual mode;
The frequency is manually tuned in steps
 - PTY Seek mode (RDS FM Radio Mode only);
The currently selected programme type station will be tuned.
 - Preset (Preset UP/DN) mode;
You can directly switch preset stations.
- 6 Touch [,] or [,] to change the radio frequency up or down respectively.**
In manual mode, touch and hold to change the frequency continuously.

- The , buttons provide the same functions above.

Presetting Stations Manually

- 1 Tune in a desired radio station you wish to store in the preset memory by manual or automatic seek tuning.**
- 2 Touch the Preset number you want to store, for at least 2 seconds.**
The selected station is stored.
- 3 Repeat the procedure to store up to 11 other stations onto the same band.**
To use this procedure for other bands, simply select the desired band and repeat the procedure.
A total of 48 stations can be stored in the preset memory (12 stations for each band; FM1, FM2, MW or LW).
 - For details on switching to the Preset mode screen, see ③ in “MW/LW band main screen example” (page 50).
 - If a preset memory has already been set in the same preset number, it will be cleared and the new station will be memorised.

Presetting Stations Automatically

The tuner can automatically seek and store 12 strong stations in the selected band in ascending order of frequency.

Select the desired band then touch and hold (Auto Memory).

The tuner automatically seeks and stores 12 strong stations into the preset buttons in ascending order of frequency. When automatic storing has completed, the station stored in the preset 1 is selected.

- If no stations are stored, the tuner will return to the original station you were listening to before the automatic storing procedure began.
- You can cancel this process by touching (Auto Memory) while the tuner is automatically seeking stations. Canceling will return the tuner preset to the previous setting.

Tuning to Preset Stations

You can tune in the preset stations in memory on either band using its preset number.

- 1 Touch .**
The radio band select pop up screen is displayed.
 - button displays the current selected band. (e.g. [FM1])
- 2 Select the desired band from FM1/FM2/MW/LW.**
- 3 Touch any one of the Preset numbers you have already stored in the Preset mode screen.**
The preset station is received.
 - For details on switching to the Preset mode screen, see ③ in “MW/LW band main screen example” (page 50).
 - You can also switch the preset station by touching or when the tuning mode of “Preset” is chosen.

Inputting Frequency Directly and Receiving the Radio Station

You can input a frequency of the same band directly and receive the radio station.

1 Touch [] (Direct Tune).

The numeric keypad input mode screen appears.

2 Touch a desired number.



Touch [] to delete an entered number.

Touch [**Delete All**] to delete all entered numbers.

3 Touch [**Enter**] on the numeric keypad mode screen to confirm your selection.

Touch [] to hide the keypad display.

RDS Operation

Turning AF (Alternative Frequencies) On or Off

The RDS (Radio Data System) is a radio information system using the 57 kHz subcarrier of regular FM broadcasts. The RDS allows you to receive a variety of information such as traffic information, station names, and to automatically re-tune to a stronger transmitter that is broadcasting the same programme.

Touch [] (AF) to select the AF (Alternative Frequency) ON or OFF mode.

In AF ON mode, the “AF” Indicator lights up.

- RDS mode is not displayed for the MW or LW band.
- When the AF ON mode is selected, the unit automatically tunes to a strong signal station in the AF list.
- Use the AF OFF mode when automatic re-tuning is not required.

Tips

- The RDS digital data includes the following:

PI	Programme Identification
PS	Programme Service Name
AF	List of Alternative Frequencies
TP	Traffic Programme
TA	Traffic Announcement
PTY	Programme Type
EON	Enhanced Other Networks
- Refer to page 41 about “PI SEEK Setting,” “Receiving RDS Regional (Local) Stations,” “Switching the Display Language of PTY (Programme Type)” and “Setting PTY31 (Emergency Broadcast) Reception.”

Interruption Function



If the Interruption Function is enabled, when the following broadcast is received, the unit switches to the Radio source screen automatically, and will receive broadcasts.

- PTY31 (Emergency Broadcast)*1, 2
- TA (Traffic Announcement)*3
- News programme*2

*1 Set PTY31 to “On” in “Setting PTY31 (Emergency Broadcast) Reception” (page 41).

*2 Not interrupted during the DAB broadcast reception.

*3 The Interruption Function for Traffic Announcements works with DAB broadcasts. Therefore, even if the current source is RDS, a Traffic Announcement by DAB broadcast may interrupt.

- “RDS Alarm”/“RDS T.Info”/“RDS News” is displayed in the Band display section during each respective broadcast reception.
- To cancel the Interruption function, touch the RDS main screen or press any of the following buttons.
/(Favourite)/MENU//▶▶▶/◀ (NAV)
- When the interruption broadcast is over, the unit returns to the previous screen.
- Does not interrupt during Hands-free phone talk. During camera image display, only the sound may be interrupted.
- The volume level will be memorised if the volume is adjusted during interruption broadcast reception. When an interruption broadcast is received the next time, the volume level is automatically adjusted to the memorised level.

Receiving Traffic Announcement

Touch [] (TA).

The "TA" indicator lights up and the unit switches to standby mode for the traffic announcement.

When the traffic announcement is received, the "TP" indicator lights up and the unit switches to the radio source screen to receive it.

- The "TP" indicator lights up during standby mode off in a condition other than radio source to indicate that the unit is receiving the traffic announcement.
- If the traffic announcement broadcast signal falls below a certain level, the unit remains in the receiving mode for 1 minute. If the signal remains below a certain level for over 70 seconds, "TA" will blink in the display.

News Programme Interruption

Touch [] (News).

The "NEWS" indicator lights up and the unit switches to standby mode for the News programme. When the News programme is received, the unit switches to the radio source screen to receive it.

Receiving Traffic Information Manually

1 Touch [] (TA) to turn on the Traffic Information mode.

The "TA" indicator lights up.

2 Touch [] or [].

Seeks the broadcast station which is broadcasting the traffic information.

- You can seek the traffic information in DX Seek mode or Local Seek mode.

Selecting the Receivable PTY

You can select and receive the currently receivable stations in the PTY list screen.

1 Touch the PTY list button.

The Select PTY list screen is displayed.

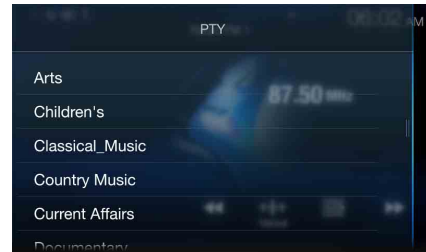

- For details on switching to the PTY list screen, see ⑥ in "Preset mode screen example" (page 50).

■ PTY list screen example



2 Select the desired programme type in the PTY list screen.

PTY Seek starts and the receivable programme type is received. If no PTY station is found, "No PTY." will be displayed.

- Touch [] or [] to select the same programme type station as the currently selected programme type after switching the tuning mode to PTY (PTY Seek) mode.

Displaying Radio Text

Text messages from a radio station can be displayed.

1 Tune in a radio station that transmits text messages.

2 Touch [] (Info) in the FM radio mode repeatedly to switch to the desired display.

Station Info.Mode → Radio Text Mode → Station Info.Mode

Station Info. Mode

PTY/Frequency or PS/Artist Name/Song Name/Album Name

Radio Text Mode

Frequency/Radio Text

DAB/DAB+/DMB

DAB main screen example

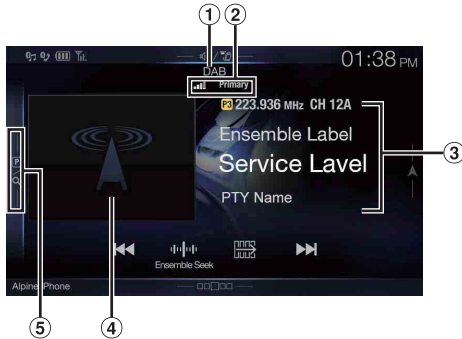

Function mode

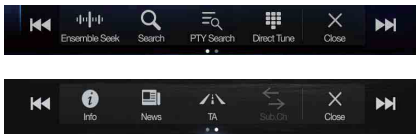

- ① Source Title/Announcement
- ② DAB indicator (Signal Strength/Service Component/FM Linking)
- ③ Info area
 - Station Info Mode
Frequency, Channel No./Ensemble Label/Service Label/PTY Name
 - Dynamic Label Mode
Dynamic Label (Displaying the information related to the current receiving station)
 - For details on switching the display, see “Displaying DAB Text” (page 57).
- ④ Slide Show
 - Displays the program information, artist photos, and advertisements that are synchronised with the Service component currently being received.*
 - You can change the artwork position. For details, see “Switching the Artwork Position” (page 38).
- ⑤ Preset mode button
Touch or swipe to the right when you use the Preset mode screen.

* They may not be displayed, depending on the Service component currently being received.

Preset mode screen example

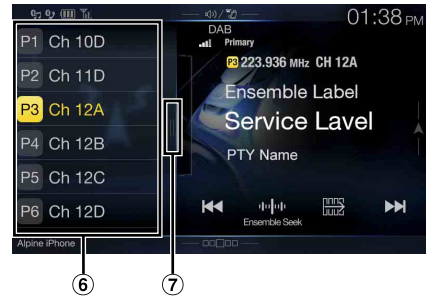

- ⑥ Preset button
Swipe vertically in the list to change pages.
 - ⑦ Full Search mode button (All Service list, Current Ensemble list or PTY list is displayed)
Swipe to the right when you use the Full Search mode screen.
- Confirm the type of DAB antenna (sold separately) before using the DAB/DAB+/DMB function. If an active antenna that needs power supply from this unit is used, set DAB Antenna Power to On; if a passive antenna that does not need power supply from this unit is used, make sure to set DAB Antenna Power to Off, otherwise, a malfunction may occur. See “Setting the DAB Antenna ON/OFF” (page 42).
 - When FM Linking is set to On, if the digital signal is weak, this unit will switch to receive the analogue FM radio signal automatically and the source icon for Radio displays as FM Linking. For details, see “Setting the FM Linking ON/OFF (Service Following)” (page 42).
 - This product does only support the “Receiver Profile 1 - Standard Audio Receiver” according to the official classification of WorldDMB Forum.

Listening to DAB/DAB+/DMB

- 1 Press the **🎵 (AUDIO)** button to select DAB mode.
The display shows the DAB mode screen.
 - You can select and change the source from the Menu screen (page 19) or the Favourite screen (page 22).
- 2 Touch **[🔍]**.
The tuning mode selection popup is displayed.
 - **[🔍]** button displays the current selected mode. (e.g. [Ensemble Seek])
- 3 Touch the desired tuning mode.

Ensemble Seek	Ensemble Manual	PTY
⏪ ⏩	⏪ ⏩	⏪ ⏩
Service	Preset	
⏪ ⏩	⏪ ⏩	

 - Ensemble Seek mode;
Receivable ensembles will be tuned in automatically.
 - Ensemble Manual mode;
Each ensemble is tuned in one step at a time manually.
 - PTY Seek mode;
Service (Primary Component) of the selected PTY will be tuned in.
 - Service (Service Up/Down) mode;
Service Components in the All Service list will be switched.
 - Preset (Preset UP/DN) mode;
The Preset station will be tuned in directly.

4 Touch [◀]/[▶], [◀◀]/[▶▶] or [◀◀◀]/[▶▶▶] to change the Service or Ensemble up or down respectively.

Touch and hold to change the Service or Ensemble continuously.

- The ◀◀, ▶▶ buttons provide the same functions above.

Presetting Service

1 Select the band and ensemble, and then tune in a desired service you wish to store in the preset memory.

2 Touch the preset number you want to store, for at least 2 seconds.

The selected station is stored.

The display shows the service label or channel number memorised.

3 Repeat the procedure to store up to 17 other stations onto the same band.

To use this procedure for other bands, simply select the desired band and repeat the procedure.

- A total of 18 services can be stored in the preset memory.
- If you store a service in a preset memory which already has a service, the current service will be cleared and replaced with the new service.
- For details on switching to the Preset mode screen, see ⑤ in “DAB main screen example” (page 54).

Tuning to Preset Service

You can tune in the preset stations in memory on either band using its preset number.

Touch any one of the preset buttons that has a service stored to it.

The preset service is received.

- For details on switching to the Preset mode screen, see ⑤ in “DAB main screen example” (page 54).

Service Component/PTY Search Function

You can select your favourite Service Component from the All Service list, Current Ensemble Service list or PTY Search list.

Service Search Function

1 Touch [🔍] (Search).

- You can also touch the ⑦ Full Search mode button in the Preset mode screen or swipe to the right to display.

2 Touch [☰] (All) or [☰] (Current Ensemble).

The All Service list or Current Ensemble list in the Full Search mode screen is displayed.

ALL: All the currently available Service Component (Primary/Secondary) lists are displayed.

Current Selectable Service Component (Primary/Secondary) lists
Ensemble: from the Ensemble currently being received are displayed.

3 Touch the desired Service component.

The Selected service component is received.

- A Secondary Service list that was derived from the Primary Services is displayed in the Service Component list.
- The TP indicator is displayed in the Service Component (Primary) list currently being received.
- The PTY is displayed in the Service Component (Primary) list currently being received.
- You can also narrow down the options and search the Service name using the alphabet search function. (Primary Component only) For details, see “Alphabet Search Function” (page 63).

PTY Search Function

1 Touch [☰] (PTY Search).

A programme type list that was derived from the Primary Services currently being received as Service components is displayed.

- You can also touch the ⑦ Full Search mode button in the Preset mode screen or swipe to the right to display.
- When the All Service list or Current Ensemble list screen is being displayed, touch [🔍] (PTY).

2 Touch the desired programme type.

The Service Component list that corresponds with the selected programme type is displayed.

3 Touch the desired Service Component.

The selected Service Component is received.

List Update Function

You can update each list while it is being displayed.

Touch [🔄] (List Update).

The list is updated to the currently available list.

Interruption Function

If Interruption Function is enabled, when the following broadcast is received, the unit switches to the DAB source screen automatically, and will receive broadcasts.

- Alarm (Emergency Broadcast)*1,2
- TA(Traffic Announcement)*4
- Announcement*2,3
- News Announcement*2

*1 Set Alarm to "On" in "Setting Alarm (Emergency Broadcast) Reception" (page 42).

*2 Not interrupted during the RDS broadcast reception.

*3 Select the Announcement type received in "Setting Announcement Reception" (page 42), then set the Announcement setting to "On."

*4 The Interruption Function for Traffic Announcements works with RDS broadcasts. Therefore, even if the current source is DAB, a Traffic Announcement by RDS broadcast may interrupt.

- "DAB Alarm"/"DAB T.Info"/"DAB News" is displayed respectively on the Source title section during each broadcast reception. The display differs during announcement reception depending on the announcement type set in "Setting Announcement Reception" (page 42).
- To cancel the Interruption function, touch the DAB main screen or press any of the following buttons.
♪/(Favourite)/MENU/◀◀/▶▶/⏻(NAVI)
- When the interruption broadcast is over, the unit returns to the previous screen.
- Does not interrupted during Hands-free phone talk. During camera image display, only the sound may be interrupted.
- The volume level will be memorised if the volume is adjusted during interruption broadcast reception. When an interruption broadcast is received the next time, the volume level is automatically adjusted to the memorised level.

Receiving Traffic Announcement

Touch [📶] (TA).

The "TA" indicator lights up and the unit switches to standby mode for the traffic announcement.

When the traffic announcement is received, the "TP" indicator lights up and the unit switches to the DAB source screen to receive it.

- The "TP" indicator lights up during standby mode off in a condition other than the DAB source to indicate that the unit is receiving the traffic announcement.
- This setting works interlocked with the traffic announcement (Emergency Broadcast) of RDS.

News Programme Interruption

Touch [📰] (News).

The "NEWS" indicator lights up and the unit switches to standby mode for the News announcement.

When the News announcement is received, the unit switches to the DAB source screen to receive it.

- This setting works interlocked with the News announcement (Emergency Broadcast) of RDS.

Inputting Channel Number Directly and Receiving the Broadcasts

You can receive your desired station by inputting the channel number directly.

1 Touch [🔢] (Direct Tune).

The numeric keypad input mode screen appears.

2 Input the desired channel number.

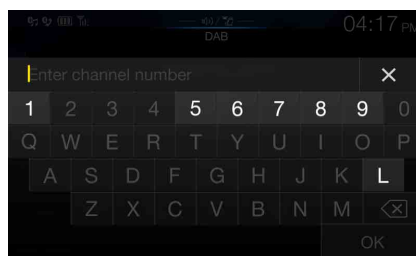

You can enter channel numbers of up to three digits.

Each time you enter a number, receivable channels will be narrowed down.

- Touch [⌫] to delete an entered number.
To delete all the numbers you have entered, touch [⌫] for at least 2 seconds.

3 Touch [OK].

Switching to Secondary Service Components

When the current Service Component includes Secondary Service components, the Function mode switch [↔] (Sub.Ch) becomes available.

Touch [↔] (Sub.Ch).

The Primary indicator switches to the Secondary indicator, and the Secondary Service Component is received.

- When the Secondary Service Component finishes, the unit automatically switches to the Primary Service Component.
- Touch [↔] (Sub.Ch) again to switch to the Primary Service Component while receiving the Secondary Service Component.
- If there are more than one Secondary Service Component, each time you touch [↔] (Sub.Ch) the indicator changes in the order of Secondary1 → Secondary2 ... → Primary.

Displaying DAB Text

Text messages from a DAB station can be displayed.

- 1 Tune in a DAB station that transmits text messages.**
- 2 Touch [] (Info) in the DAB mode repeatedly to switch to the desired display.**

Station Info Mode → Dynamic Label Mode → Station Info Mode

Station Info Mode

Frequency, Channel No./Ensemble Label/Service Label/PTY Name

Dynamic Label Mode

Dynamic Label (Displays the information related to the current receiving station)

About DAB/DAB+/DMB

What is DAB?

DAB (Digital Audio Broadcasting) is the third generation broadcasting technology following the traditional analogue technologies such as FM. The advantages of DAB include being more robust with regard to noise, interference, instability, etc., during radio signal transmission. Also, it can provide stereo CD-quality sound and digital information, and it can resist multipath interference guaranteeing high-quality reception for fixed, portable and mobile devices.

What is DAB+?

WorldDMB, the organisation in charge of the DAB standards, announced DAB+, a major upgrade to the DAB standard in 2006, when the HE-AAC v2 audio codec (also known as eAAC+) was adopted. The new standard, which is called DAB+, has also adopted the MPEG Surround audio format and stronger error correction coding in the form of Reed-Solomon coding. DAB+ has been standardised as ETSI TS 102 563.

What is DMB?

DMB (Digital Multimedia Broadcasting) is a future-orientated, new generation broadcasting system based on DAB (Digital Audio Broadcasting). Where DAB upgraded the traditional analogue sound of FM to a CD-quality level, DMB advances simple sound broadcasting to the multimedia arena, striving to provide a visual service while transmitting high-quality sound. Users include entertainment programmes, intellectual traffic navigation, electronic newspapers and magazines, information provided by financial markets, the Internet, and integrated city information. It can be widely used by mobile carriers such as buses, taxis, light railways, underground railways, trains, ferries, airports, and by all kinds of people in the home and office.

USB Flash drive (Optional)

You can play back music files (MP3/WMA/AAC/FLAC) and video files (AVI/MKV/MP4) stored in a USB flash drive on the internal player of this system.

⚠ WARNING

It is dangerous (and illegal in many states) for the driver to watch TV/video while driving the vehicle. The driver may be distracted from looking ahead and an accident could occur.

Install the unit correctly so that the driver cannot watch TV/video unless the vehicle is stopped and the emergency brake is applied.

If the unit is not installed correctly, the driver will be able to watch TV/video while driving the vehicle and may be distracted from looking ahead and cause an accident. The driver or other people could be severely injured.

■ USB Audio main screen example

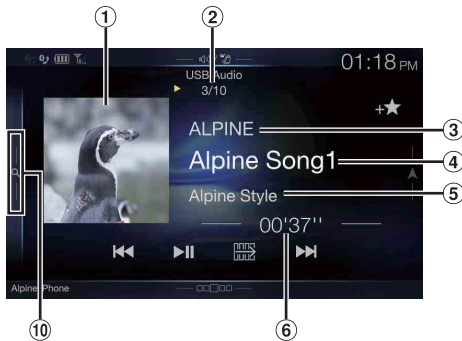

Function mode



■ USB Video main screen example

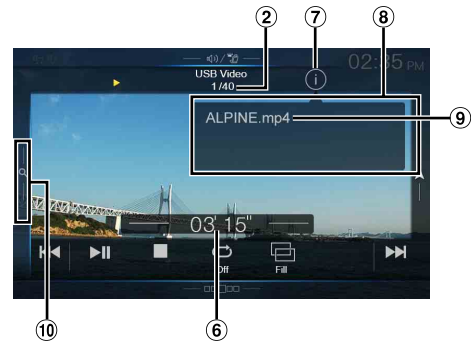

- ① Artwork display
 - You can change the artwork position. For details, see "Switching the Artwork Position" (page 38).
- ② Current track no./Total song no.
- ③ Artist title
- ④ Song title
- ⑤ Album title
- ⑥ Elapsed time
- ⑦ Info mode switching button
- ⑧ Info mode display
- ⑨ File Name
- ⑩ Quick Search button
 - Touch or swipe to the right to use the Quick Search mode.

■ Quick Search mode screen example

Swipe vertically in the list to change pages.

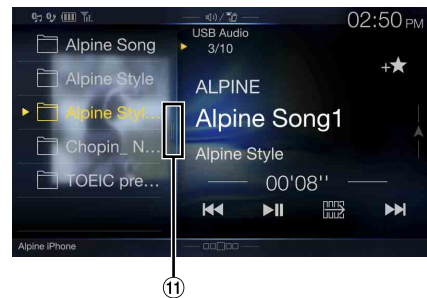

- ⑪ Full Search mode button
 - Swipe to the right when you use the Full Search mode screen.

The USB Video operation screen display during video file playback

Touch the screen while the USB Video playback screen is displayed.

The USB Video operation screen is displayed.

- The operation screen changes to the visual screen in the USB Video mode for 5 seconds after an operation has been performed.
- For your safety, video is not displayed and only audio can be heard while driving.

Playback

- 1 Press the  (AUDIO) button to select USB mode.**
The display shows the USB mode screen.
 - You can select and change the source in the Menu screen (page 19) or Favourite screen (page 22).

- 2 Touch [] or [] to select the desired track (file).**

Returning to the beginning of the current (or previous) track (file):

Touch [].

Fast reverse*:



Touch and hold [].

Advancing to the beginning of the next track (file):

Touch [].

Fast forward*:

Touch and hold [].

- The ,  buttons provide the same functions above.

- 3 To pause playback, touch [/III].**



Touching [/III] again will resume playback.

During playback, the [] indicator is displayed in Audio main screen. During a pause, the [III] indicator is displayed in the Audio main screen.

* For details on Fast-forwarding/Fast-reversing during USB video playback, see “Fast-forwarding/Fast-reversing (USB Video only)” (page 59).

- The playback time may not be correctly displayed when a VBR (Variable Bit Rate) recorded file is played back.
- If there is tag information, artist name/album name/track name is displayed.
- ID3 tag/WMA tag
If an MP3/WMA/AAC/FLAC file contains ID3 tag/WMA tag information, the ID3 tag/WMA tag information is displayed. (e.g., song name, artist name, and album name)

Fast-forwarding/Fast-reversing (USB Video only)

- 1 During playback, touch and hold [] (Fast-reverse) or touch and hold [] (Fast-forward).**

Touch and hold for more than 1 second to forward/reverse at 8x speed. Keep touching to switch the speed to 16x and 32x.

- 2 Release [] or [] to return to normal playback.**

- No sound is played back during fast-forwarding/fast-reversing.

Stopping Playback (USB Video only)

Touch [] during playback.

“STOP” indicator is displayed, and playback stops.

- Playback starts from the beginning when [/III] is touched while playback is stopped.

Repeat Play

- 1 Touch [].**

The Repeat mode select pop up screen is displayed.

- The [] button displays the currently selected mode.

- 2 Select your desired Repeat mode.**

Folder : Only files in a folder are repeatedly played back.

File : Only the file currently playing is repeatedly played back.

OFF : Repeat mode Off.

Random Play (USB Audio only)

- 1 Touch [].**

The Random Play mode select pop up screen is displayed.

- The [] button displays the currently selected mode.

- 2 Select your desired Random Play mode.**

ALL : All songs in the USB flash drive are played back in random sequence. Any one song does not play back again until all songs have been played back.

Folder : A Folder is selected randomly and songs in the Folder are played back in order. After all songs are played in a Folder, the next Folder is selected randomly.

File : Only files in a folder are played back in random sequence.

OFF : Random mode Off.

- If you select a track by using the search mode, the Random Play mode will be cancelled.

Searching for a Desired Song

You can search for your desired song by using one of two modes; the Quick Search mode and the Full Search mode.

Quick Search mode

Touch your desired Folder name or File name.

The selected Folder*¹ or File is played.

*1 The first file in the selected folder is played back.

- For details on switching to the Quick Search mode, see ⑩ in “USB Audio main screen example” (page 58).

Full Search mode

1 Touch [Audio] or [Video] to switch whether the search list displays music files or video files.

2 Touch your desired Folder name*² or File name.

When you select a File name, the selected song is played.

When you select a Folder name, repeat the same procedure to select another Folder name or File name.

*2 When you touch the [▶] by a Folder name, the unit plays from the first song in the Folder.

- For details on switching to the Full Search mode, see ⑪ in “Quick Search mode screen example” (page 58).
- To switch the displayed list or return to the previous page in the Full Search mode, see “About Basic Operation for List Screen” (page 17).

Switching Display Modes (During Video File Play Back)

You can switch the Display Mode while playing a Video File.

Touch [].

Each time you touch, the Display Mode is switched.

Fit → Fill → Fit

- The [] button displays the currently selected mode. (e.g. [Fit])
- You cannot operate them while driving.

Fit mode



The mode displays a picture while holding its aspect ratio.

- Black bands appear at the top/bottom or right/left side of the screen depending on the picture.

Fill mode



The mode displays a picture to fit its size vertically and horizontally with the monitor size.

About USB Video format

The video formats (USB Flash drive) supported by the unit are as follows.

- Supported Container: AVI, MKV, MP4
- Supported Video Coding: H.264/MPEG-4 AVC
- Supported Audio Coding: MP3, ACC, MPEG2 audio
- MAX File Size: 4GB

iPod/iPhone (Optional)

A separately sold Lightning to USB cable (KCU-471i), etc., is required. When the unit is connected by the above cable, the controls on the iPod are disabled.

- This unit does not support video playback from iPod/iPhone which connected to this unit via USB Connector.
- Internet or telephone functions, etc., of the iPhone or iPod touch are not controllable from the unit, but these functions can be controlled using the iPhone or iPod touch itself.
- Before an iPhone 5 or later is connected, turn Apple CarPlay to Off, then play iPod music. (page 43)

About iPod/iPhone models usable with this unit

- The following devices have been tested and shown to work with this unit. Correct function of earlier versions cannot be guaranteed.
 - iPod touch 6th generation: Ver.10.1.1
 - iPod touch 5th generation: Ver.9.3.5
 - iPod nano 7th generation: Ver.1.0.4
- The following devices have been tested and shown to work with this unit. Correct function of earlier versions cannot be guaranteed.
 - iPhone SE: Ver.10.1.1
 - iPhone 6S Plus: Ver.10.1.1
 - iPhone 6S: Ver.10.1.1
 - iPhone 6 Plus: Ver.10.1.1
 - iPhone 6: Ver.10.1.1
 - iPhone 5S: Ver.10.1.1
 - iPhone 5C: Ver.10.1.1
 - iPhone 5: Ver.10.1.1
 - iPhone 4S: Ver.9.3.5

■ iPod/iPhone main screen example

Audio mode



Function mode

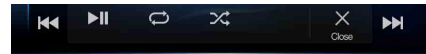

- ① Artwork display
 - You can change the artwork position. For details, see "Switching the Artwork Position" (page 38).
- ② Current song no./Total song no.
- ③ Artist title/Release Date*1
- ④ Song title/Episode title*1
- ⑤ Album title/Podcast title*1
- ⑥ Total time for playing
- ⑦ Elapsed time
- ⑧ Quick Search button*2
 - Touch or swipe to the right when using Quick Search mode.

*1 Podcast mode.

*2 If you have never used Search mode with the currently connected iPod/iPhone, pressing the Quick Search button switches the screen to the Full Search mode screen.

■ Quick Search mode screen example

Swipe vertically in the list to change pages.



- ⑨ Full Search button
 - Swipe to the right when using Full Search mode.

Playback

1 Press the (AUDIO) button to select iPod mode.

The display shows the iPod mode screen.

- You can select and change the source in the Menu screen (page 19) or Favourite screen (page 22).

2 Touch [] or [] to select the desired track (file).

Returning to the beginning of the current (or previous) track (file):

Touch [].

Fast reverse the current track :



Touch and hold [].

Advancing to the beginning of the next track (file) :



Touch [].

Fast forward the current track :

Touch and hold [].

- The ,  buttons provide the same functions above.

3 To pause playback, touch [/III].

- If a song is playing on the iPod/iPhone before it is connected to the unit, it will continue playing when it is connected.
- An episode may have several chapters. The chapter can be changed by touching [] or [].
- If the artist, album or song name, created in iTunes, has too many characters, songs may not be played back when connected to the unit. Therefore, a maximum of 64 characters is recommended. The maximum number of characters for the unit is 64.
- Some characters may not be correctly displayed.

Searching for a Music File

An iPod/iPhone can contain thousands of songs. For this reason, this unit can make various searches using the search function as shown below.

Using the Playlist/Artist/Album/Podcast/Audiobook/Genre/Composer/Song/iTunes Radio search mode's individual hierarchy, you can narrow down your search as shown in the table below.

<MUSIC Search Menu>

Hierarchy 1	Hierarchy 2	Hierarchy 3	Hierarchy 4
Playlists	Songs	—	—
Artists	Albums	Songs	—
Albums	Songs	—	—
Songs	—	—	—
Podcasts	Episodes	—	—
Genres	Artists	Albums	Songs
Composers	Albums	Songs	—
Audiobooks	—	—	—
iTunes Radio	—	—	—

Quick Search Mode

In Quick Search mode, the list from the previous search mode is displayed. For example, if the last time you searched for songs was in Albums, the Album list is displayed. If you have not used the search mode, the list is not displayed in the Quick Search mode. In this case, go to the Full Search mode.

In Quick Search mode, touch the desired list (for example, Album list).

The selected Album is played.

- To switch into Quick Search mode, see  in "iPod/iPhone main screen example" (page 61).
- To search within an Album, go to the Full Search mode.

Full Search Mode

For example: Searching by Artist name

The following example explains how an Artists search is performed. Another search mode can be used for the same operation, although the hierarchy differs.

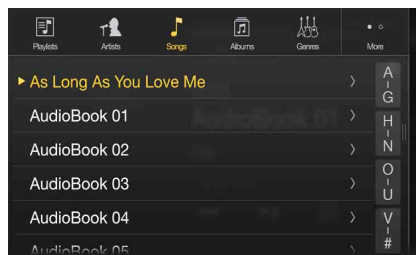

1 Touch [Artists] in the Full Search mode screen.

The Artists search screen is displayed.

- To switch into Full Search mode, see  in "Quick Search mode screen example" (page 61).

2 Select the desired artist.

To play back the Artist directly

- Touch [] of the artist's name.
All songs of the selected artist are played back.

To search for the Album of the Artist

- Touch the selected artist name.
The Albums search screen of the selected artist is displayed.
- Touch [] of the desired album's name.
All songs of the selected album are played back.

To search for a Song in the Album of the Artist

- Touch the desired artist's name.
All albums of the selected artist are displayed.

3 Touch the desired album's name.

All songs of the selected album are displayed.

4 Touch the desired song's name.

The selected song is played back.

- An alphabet skip function is available. See "Alphabet Search Function" (page 63).
- To switch the displayed list or return to the previous page in the Full Search mode, see "About Basic Operation for List Screen" (page 17).

Alphabet Search Function

The unit is provided with an alphabet search function for effective searching. When you use this function in the search mode, you can quickly search an artist or a song, etc.

This is an example of how to search Artist Name for names beginning with “R”.

1 Touch “O-U” of the alphabet group.

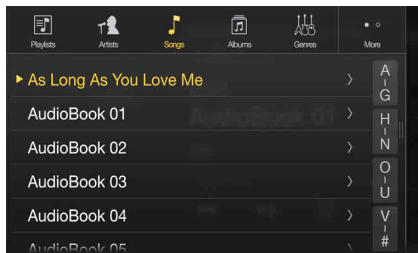

“O P Q R S T U” of the alphabet group “O - U” is displayed.

2 Touch “R” you want to search.

Artist names beginning with “R” are displayed.

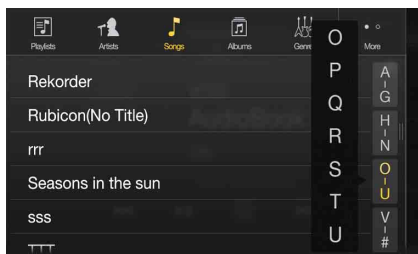

3 Touch your desired artist name.

- If there are no names in the list beginning with that letter, the next letter of the alphabet is searched.

For example: If there are no names beginning with “R,” the search list begins with “S.”

Repeat Play

Touch [🔁] to repeatedly play back the currently track.

The tracks (files) will be played repeatedly.

Touch [🔁] again to deactivate Repeat play.

Repeat All → Track Repeat [🔁] → OFF [🔁] → Repeat All

Random Play (Shuffle)

1 Touch [🔀].

The Random Play mode select pop up screen is displayed.

- The [🔀] button displays the currently selected mode.

2 Select your desired Random Play mode.

The selected Random Play mode changes the button.

Album [🔀]: The songs on each album are played back in proper order. Upon completing of all the songs on the album, the next album is selected randomly. This continues until all albums have been played.

Songs [🔀]: Song shuffle randomly plays back songs within a selected category (playlist, album, etc.). The songs within the category are played just once until all songs have been played.

OFF [🔀]: Random mode Off.

- The action depends on the connected iPod.

HDMI Device (Optional)

Devices supporting HDMI can connect and play back through this unit (for example, an optional DVE-5300 (DVD Player), iPhone or other Smartphones). When making HDMI connections, you need to set HDMI on the unit suitable for the connected device. For details, see “HDMI Setup” (page 43).

- The HDMI/MHL connecting cable differs depending on the connected device corresponding to HDMI. Prepare optional HDMI/MHL connecting cable sets suitable for your device.

When you connect an optional DVE-5300 (DVD Player), you can operate it from the unit. For details on how to operate the DVD player, see “DVD Player Operation” (page 64).

For details on how to operate iPhones and Smartphones, see “HDMI Operation” (page 70).

- The HDMI connector is for use exclusively with a standard DVD Player. Other HDMI devices (i.e. iPhone, etc.) cannot be used.

About HDMI selector (Optional)

HDMI selector is used when you add HDMI devices (iPhone or other Smartphones).

- Set “Setting the HDMI Selector On/Off” (page 48) to “On” when using the HDMI selector.
- For details on how to switch the HDMI source by using the HDMI selector, see “Switching the source when two HDMI devices are connected” (page 70).

DVD Player Operation

You can operate discs using the Remote Control unit supplied with the DVE-5300 (DVD Player). For details on operating the Remote Control unit, refer to the Owner’s Manual of the DVE-5300.

- For details on the types of playable discs and formats, refer to the Owner’s Manual of the DVE-5300.

DVD Player SETUP

You can setup only when a disc is not inserted or playback pauses.

- For details on the setting items, refer to the Owner’s Manual of the DVE-5300.

1 Touch [⚙] (Setup).

The Setup main screen is displayed.

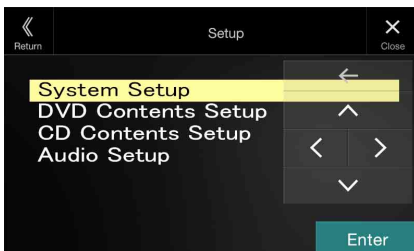

Setting items:

System Setup / DVD Contents Setup / CD Contents Setup / Audio Setup

- 2 Touch [^] or [v] to select the setting item.
- 3 Touch [Enter], then touch [<], [>], [^] or [v] to change the setting item.
- 4 Touch [X] to return to the main source screen.

- Touch [⏪] (Return) to return to the previous display.
- For details on the [⚙] (Setup) button, see Function mode in “CD/MP3/WMA/AAC/WAV” (page 64) or “DVD” (page 66).

CD/MP3/WMA/AAC/WAV

■ MP3/WMA/AAC main screen example

Info mode

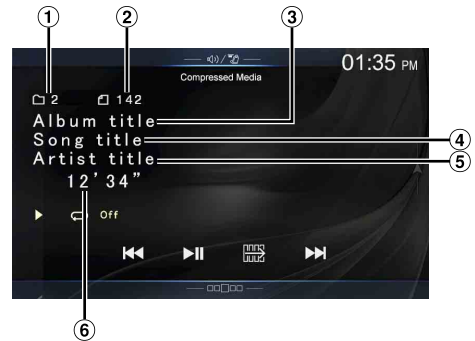

Function mode (MP3/WMA/AAC)

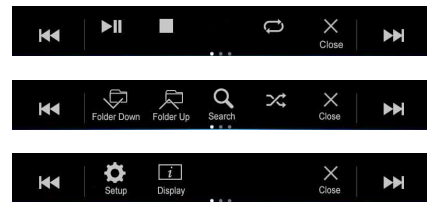

- ① Current song no.
- ② Total song no.
- ③ Album title
- ④ Song title
- ⑤ Artist title
- ⑥ Elapsed time

Function mode (CD)



- If there is no CD text, the message “No Text” appears.

Playback

- 1 Press the (AUDIO) button to select DVD (CD) mode. The display shows the DVD (CD) mode screen.
 - You can also select and change from the Menu screen (page 19) or Favourite screen (page 22).

When a disc is inserted into the disc slot of the DVD Player, with the label side facing up, the unit starts playback of the disc.

- 2 Touch [] or [] to select the desired track (file).

Returning to the beginning of the current (or previous) track (file):

Touch [].

Fast reverse :

Touch and hold [].

Advancing to the beginning of the next track (file) :

Touch [].

Fast forward :

Touch and hold [].

- The , buttons provide the same functions above.

- 3 To pause playback, touch [/||].

- Any file protected by DRM (Digital Rights Management) copy protection, cannot be played back on this unit.
- If a disc contains both audio data and MP3/WMA/AAC/WAV data, this unit plays back only the audio data.
- The track display for CD audio data playback shows the track numbers recorded on the disc.
- If an MP3/WMA/AAC/WAV disc with many files and folders is played, it may take longer than normal to start playback.
- The playback time may not be correctly displayed when a VBR (Variable Bit Rate) recorded file is played back.

Stopping Playback

Touch [] during playback.

“STOP” indicator is displayed, and playback stops.

- Playback starts from the beginning when [/||] is touched while playback is stopped.

Repeat Play

Touch [] to repeatedly play back.

The tracks (files) will be played repeatedly.

The repeat mode switches every time the button is touched.

CD:

Track Repeat → Off → Track Repeat

MP3/WMA/AAC:

Repeat File → Repeat Folder* → Off → Repeat File

- * Only files in a folder are repeatedly played back.

- If the Repeat Play mode is activated during MIX playback, the MIX mode will be cancelled.

MIX (Random Play)

Touch [] during playback.

The tracks (files) on the disc will be played back in a random sequence.

The MIX mode switches every time [] is touched.

CD:

MIX → Off → MIX

MP3/WMA/AAC:

MIX Folder*1 → MIX (Disc)*2 → Off → MIX Folder*1

*1 Only files in a folder are played back in random sequence.

*2 All files on the disc will be played back in a random sequence.

- If the MIX mode is activated during Repeat playback, the Repeat Play mode will be cancelled.
- If you select a track by using the search mode, the MIX play mode will be cancelled.

File/Folder Name Search (Concerning MP3/WMA/AAC/WAV)

- 1 Touch [] (Search) during playback.

The search mode is activated.

The mode is changed to the search mode, and the list select panel appears.

- 2 Touch [] or [] in the list select panel to select Folder or File, then touch [Enter].

When selecting Folder, select File following same procedure, then touch [Enter].

- When there are 9 or more names on the list, a page number is displayed. Touch [] or [] to change the page.
- Touch [] or [] to change the list select panel location from right to left or vice-versa.
- To return to the previous hierarchy, touch [].

Selecting Folders (Concerning MP3/WMA/AAC/WAV)

Touch [] (Folder Down) or [] (Folder Up) to select the folder.

Info Mode Function

You can display the DISC information.

- 1 During playback, touch [] (Display).

The playback status is displayed.

- 2 The playback status display closes when [] (Display) is touched.

- For details on the display example, see Info mode in “MP3/WMA/AAC main screen example” (page 64).

DVD

DVD Video main screen example

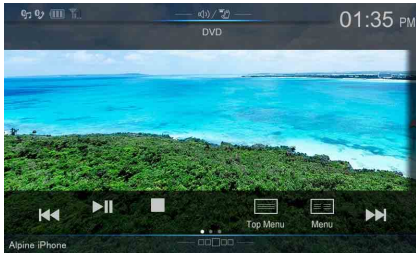

Function mode



Info mode



- ① Title no./Chapter no.
- ② Audio signal output/Subtitle/Angle
- ③ Elapsed time

Video CD main screen example

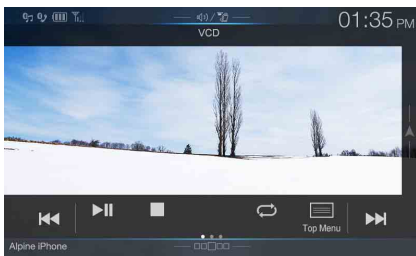

Function mode



Info mode



- ① Current track no.
- ② Playback control (PBC)/Current audio status
- ③ Elapsed time

Disc types that can be used for each heading are represented by the following marks.



DVD Commercial Video discs (used for the distribution of movies, etc.) or a DVD-R/DVD-RW, DVD+R/DVD+RW recorded in a video mode can be used.



Video-CD discs can be used.

The DVD operation screen display

Touch the screen while the DVD playback screen is displayed. To display the operation screen, touch [Control].



- The operation screen changes to the visual screen in the DVD mode for 5 seconds after an operation has been performed.
- If you try to activate the DVD while driving, the display will show the warning-Picture off for your safety.
- Some operations cannot be carried out depending on the disc or playback screen.

Playing a Disc DVD-V V CD

WARNING

It is dangerous for the driver to watch the DVD while driving the vehicle. The driver may be distracted from looking ahead and an accident could occur.

Install the unit correctly so that the driver cannot watch DVD unless the vehicle is stopped and the emergency brake is applied.

If the unit is not installed correctly, the driver will be able to watch DVDs while driving the vehicle and may be distracted and could cause an accident. The driver or other people could be severely injured.

CAUTION

- Not all functions will operate for every DVD. See the individual DVD's instructions for details on the features supported.
- Fingerprints on a disc may adversely affect playback. If a problem occurs, remove the disc and check for fingerprints on the playback side. Clean the disc if necessary.
- If you switch the power or Ignition key OFF or change sources during playback, playback will continue where you left off when you resume playback.
- If you try to perform an invalid operation (based on the type of disc being played), the following mark is displayed on the monitor screen: 

- **Play Position Memory Function**
Even if you turn power off or switch the Ignition key to OFF during playback or change the source, playback will continue from the point where playback stopped when the power is turned ON again.

1 Press the (AUDIO) button to select DVD (CD) mode.

The display shows the DVD (CD) mode screen.

When a disc is inserted into the disc slot of the DVD Player, with the label side facing up, the unit starts playback of the disc.

- The reverse side of a double-sided DVD will not be played automatically.
Remove the disc, turn it over, and reinsert it.
- DO NOT insert discs containing maps for the navigation system. Doing so could result in damage.
- For your safety, video is not displayed and only audio can be heard while driving.

If a Menu Screen Appears

On DVD mode, menu screens may appear automatically. If this happens, perform the operation described below to start playback.

Direct Menu Operations DVD-V

1 Touch the screen while the DVD menu is being displayed.

Directly touch operation switches displayed on the screen to operate.

- To display the operation screen, touch [Control].

2 Touch the DVD menu directly.

- Some operations cannot be performed depending on the disc.

Menu Operations DVD-V V CD

1 Touch [] (Menu Control).

The menu operation mode will be displayed.

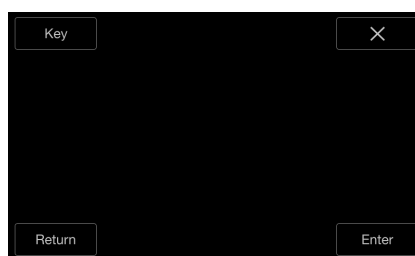

- You cannot operate them while driving.



2 Touch [Key].

The Key panel is displayed.

Touch [Return] to return to the previous display.

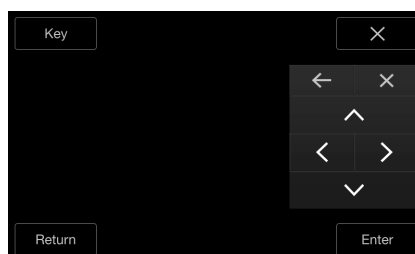
3 Select a desired menu item by touching [, [, [, or [].



- Touch [] or [] to change the Key panel location from right to left or vice-versa.
- Touching [] in the operation panel returns to the screen in step 1.
- Touching [Key] displays the numeric keypad input mode screen. For details of the numeric keypad input mode screen, see "Numeric Keypad Input Operations" (page 68).

4 Touch [Enter] to confirm the selected item.

Numeric Keypad Input Operations DVD-V

- 1 **Touch [key] again in the menu operation mode.**
The numeric keypad input mode screen appears.
- 2 **Touch a desired number.**

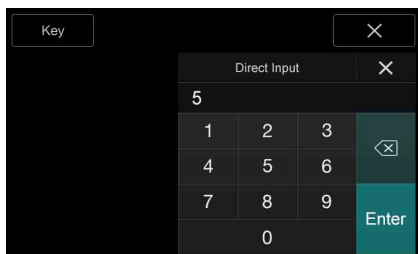

Touch [~~X~~] to delete an entered number.
To delete all the numbers you have entered, touch [~~X~~] for at least 2 seconds.

- 3 **Touch [Enter] on the numeric keypad input mode screen to confirm your selection.**

Touch [X] to hide the keypad display.

- You cannot operate them while driving.

Displaying the Top Menu Screen

DVD-V V CD

When a DVD contains two or more titles, the top menu screen appears.

Touch [≡] (Top Menu).

The top menu screen appears.

- To perform necessary operations, see “If a Menu Screen Appears” (page 67).

Displaying the Menu Screen DVD-V V CD

With a DVD having two or more menus, a menu screen will appear for the programmes available, in addition to the main programmes.

Touch [≡] (Menu).

The Root menu screen appears.

- To perform necessary operations, see “If a Menu Screen Appears” (page 67).

Playing Still Frames (Pausing) DVD-V V CD

- 1 **During playback, touch [▶/||].**

- 2 **Touch [▶/||] to resume playback.**

- No sound is played during the still frame mode.
- The image or sound may stop temporarily when playback starts from the pause mode. This is not a malfunction.

Stopping Playback DVD-V V CD

Touch [■] during playback.

“■” indicator is displayed, and playback stops.

- Playback starts from the beginning when [▶/||] is touched while playback is stopped.

Fast-forwarding/Fast-reversing DVD-V V CD

- 1 **During playback, touch and hold [⏮] (Fast-reverse) or touch and hold [⏭] (Fast-forward).**

When pressed for more than 1 second, the disc is forwarded/reversed at double speed.

When held for 5 more seconds, the disc is forwarded/reversed at 8 times the normal speed.

When held for 10 more seconds, the disc is forwarded/reversed at 32 times the normal speed.

- 2 **Release [⏮] or [⏭] to return to normal playback.**

- No sound is played back during fast-forwarding/fast-reversing.
- On DVD mode, the menu screen may reappear during fast-forwarding/fast-reversing.
- This operation may not be possible on certain discs.

Finding the Beginnings of Chapters/Tracks/Files

DVD-V V CD

During playback, touch [⏮] or [⏭].

The chapter/track/file switches each time the button is touched, and playback of the selected chapter/track/file starts.

▶▶▶: Touch this to start playback from the beginning of the following chapter, track or file.

⏮: Touch this to start playback from the beginning of the current chapter, track or file.

- Some DVDs do not have chapters.

Supplementary explanations

“Chapters” are divisions of movies or musical selections on DVDs.

“Tracks” are divisions of movies or musical selections on Video CD.

Forward/Reverse frame-by-frame Playback

DVD-V V CD

1 In the pause mode, touch [◀◀] or [▶▶].
The picture advances by one frame each time the button is touched.

2 Touch [▶/||] to return to normal mode.

- No sound is output during forward frame-by-frame playback.
- You can only execute reverse frame-by frame playback when playing DVD-V.

Repeat Playback

DVD-V V CD

Use this function to play the disc's titles, chapters or tracks, etc., repeatedly.

Touch [↺] to repeatedly play back.

The repeat mode switches every time the button is touched.

DVD Video

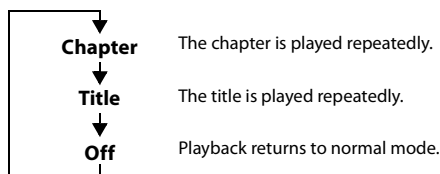

- The Repeat mode is always turned off when [↺] is touched and held for at least 2 seconds.
- Only discs containing a Playlist can be displayed.

Video CD

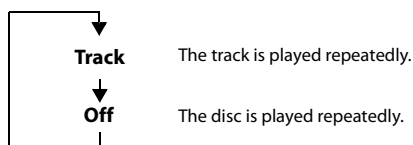

- Display may vary depending on the connected devices.
- For some discs it is not possible to switch the repeat mode.

Searching by Title Number

DVD-V

Use this function to easily find positions on the DVD using the DVD's titles. Perform operations while playback is stopped.

- 1 Touch [☰] (Menu Control).**
The menu operation mode screen appears.
- 2 Touch [Key] again in the menu operation mode.**
- 3 Enter a desired title by touching its number.**
See page 68 for operation of the numeric keypad.
- 4 Touch [Enter].**
Playback will start from the number selected.
- 5 Touch [X].**

- This function cannot be used on discs on which no title numbers are recorded.
- Some disc may not accept any operation.
- You cannot operate them while driving.

Searching Directly by Chapter Number

DVD-V V CD

Use this function to easily move to the beginnings of the chapters on the disc. Perform operations during playback, during PRE-STOP or while playback is paused.

- 1 Touch [☰] (Menu Control).**
The menu operation mode screen appears.
- 2 Touch [Key] again in the menu operation mode.**
- 3 Touch and enter the chapter number you want to play.**
See page 68 for operation of the numeric keypad.
- 4 Touch [Enter] to confirm your selection.**
Playback will start from the selected chapter.
- 5 Touch [X].**

- This function is not available for a disc on which chapters are not stored.
- You cannot operate them while driving.

Switching the Angle

DVD-V

On DVDs in which scenes have been filmed from multiple angles, the angle can be switched during playback.

Touch [☰] (Angle).

The angle switches between the angles recorded on the disc every time the button is touched.

- Some time may be required for the angle to change.
- Depending on the disc, the angle may switch in one of two ways.
 - Seamless: The angle switches smoothly.
 - Non-seamless: When the angle is switched, a still picture is displayed first, after which the angle switches.

Switching the Audio Tracks DVD-V V CD

DVDs with multiple audio tracks or languages allow switching the sound during playback.

Touch [] (Audio).

The sound switches between the alternate audio tracks recorded on the disc every time the button is touched.

- The alternate track selected becomes the default setting every time the power is turned on or the disc is replaced. If the disc does not include that track, the disc's default language is selected instead.
- Not all discs will allow changing the alternate audio tracks during playback. In these cases, select audio tracks from the DVDs menu.
- There may be a delay before the selected alternate track begins to play.

Video CDs with multiplex audio

Touch [] (Audio).

The left and right channels will be output as shown below, each time the button is touched.

Audio: LL → Audio: RR → Audio: LR → Audio: LL

Switching the Subtitles (Subtitle Language)

DVD-V

With DVDs on which multiple subtitle languages are recorded, the subtitle language can be switched during playback; moreover, subtitles can be hidden.

Touch [] (Sub Title).

Touching this button repeatedly selects sequentially the subtitle languages recorded on the disc, and then turns the subtitles OFF.

- There may be a delay before the selected subtitle appears.
- Not all discs will allow changing the subtitles during playback. In these cases, select subtitles from the DVDs menu.
- The subtitle language selected becomes the default setting every time the power is turned on or the disc is replaced. If the disc does not include that language, the disc's default language is selected instead. However, the subtitle language may differ depending on the disc.
- For some discs, the subtitles will be displayed even when this is set to OFF. However, the subtitle language may differ depending on the disc.

Info Mode Function

You can display the DISC information.

1 During playback, touch [] (Display).

The playback status is displayed.

2 The playback status display closes when [] (Display) is touched.

- For details on the display example, see Info mode in "DVD Video main screen example" (page 66) or "Video CD main screen example" (page 66).

Switching Display Modes

You can switch the Display Mode by touching [] (Display Mode).

For details, see "Switching Display Modes (During Video File Playback)" (page 60).

- You cannot operate them while driving.

HDMI Operation

■ iPhone, Smartphone, etc.

The output of your electronic device will be mirrored on this unit through the HDMI connector. Control from this unit is not possible.

- The electronic device must possess an HDMI output interface.
- Not all devices with an HDMI output interface can be recognised by this unit.
- Use only the Alpine Special HDMI connection cable.

1 Press the (AUDIO) button to select HDMI mode.

The display shows the HDMI mode screen.

- You can select and change the source in the Menu screen (page 19) or Favourite screen (page 22).
- For your safety, video is not displayed and only audio can be heard while driving.

2 In HDMI player mode, the screen of the device displays the content of electronic equipment by mirror image.

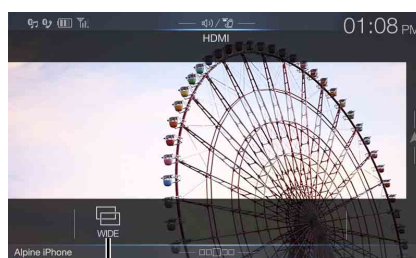

① You can select Display Mode.

For details, see "Switching Display Modes (During Video File Playback)" (page 60).

- You cannot operate them while driving.

Switching the source when two HDMI devices are connected

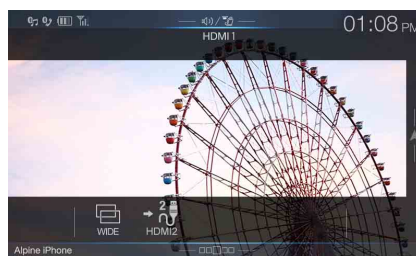

You can switch the source only when you have connected the HDMI selector and "Setting the HDMI Selector On/Off" (page 48) is set to "On."

■ Screen example when the HDMI Setup is "HDMI 1"



Touch [] (HDMI 2).

The HDMI source changes to HDMI 2, and the Function button changes to [] (HDMI 1).

Each time you touch [] (HDMI 1)* or [] (HDMI 2), the HDMI source changes.

- * When HDMI Setup is "DVD", the Function button is changed to [] (DVD).

Bluetooth Operation

Setup Before Using

About Bluetooth

Bluetooth is a wireless technology allowing communication between a mobile device or personal computer over short distances. This enables a hands-free call or data transmission between Bluetooth compatible devices. Bluetooth transmission is available in the unlicensed 2.4 GHz spectrum if the distance between devices is within 10 metres. For details, refer to the Bluetooth website (<http://www.bluetooth.com/>).

- Depending on the Bluetooth version, a Bluetooth compatible device may not be able to communicate with this unit.
- Proper function of this unit with all Bluetooth compatible devices is not guaranteed. For handling of the Bluetooth compatible device, consult your Alpine dealer or Alpine website.
- Depending on the surroundings, Bluetooth wireless connection may be unstable.
- When you place a call, or perform setup operations, be sure to stop your car in a safe place.
- Depending on the connected Bluetooth compatible device(s), the function may differ. Also refer to the Owner's Manual of the connected device(s).

About the Hands-free Phone

Hands-free calls are possible when using a HFP (Hands-Free Profile) compatible mobile phone with this unit.

- Avoid performing a hands-free call in heavy traffic or on narrow or winding streets.
- Close the windows while calling to reduce background noise.
- If both calling parties are using hands-free devices, or the call is made in a noisy location, difficulty hearing the other person's voice is normal.
- Depending on telephone line conditions or certain mobile devices used, voices may sound unnatural.
- When using a microphone, speak as directly as you can into the microphone to obtain the best sound quality.
- Certain mobile phone features are dependent on the capabilities and settings of your service provider's network. Additionally, certain features may not be activated by your service provider, and/or the provider's network settings may limit the feature's functionality. Always contact your service provider about feature availability and functionality.

All features, functionality, and other product specifications, as well as the information contained in the Owner's Manual are based upon the latest available information and are believed to be accurate at the time of printing.

Alpine reserves the right to change or modify any information or specifications without notice or obligation.

- Notice that when you connect an iPhone 5 or later/Android smartphone which installed Android Auto App, the operation screen may differ from this section.

Before Using Bluetooth

Before using the hands-free phone/audio function, the following settings need to be made.

1 Set "Bluetooth" to "On" (✓).

2 Register a Bluetooth device in this unit (page 28).

- See "Bluetooth Setup" (page 28).
- You can search for this unit using a Bluetooth compatible device, and then connect that Bluetooth compatible device to this unit. The unit name such X902D, etc., is displayed on your phone and the initial number of the passcode is "0000." Also refer to the Owner's Manual of the connected device(s).

Hands-free Phone Control

Touch [Phone] in the Menu screen to display the Phone menu screen (page 71).



[Phone] button

Phone menu screen example

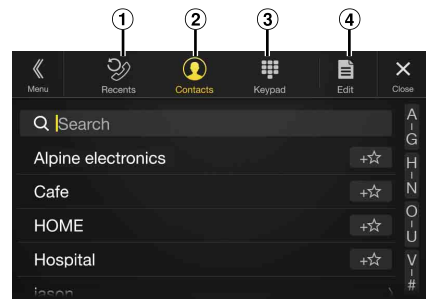

1 Recent Events list*

You can display up to 60 items, such as phone numbers of the most recent incoming calls, missed calls and outgoing calls, and contact names that are registered in the Phone Book. When 60 items exist in the list, the oldest item is deleted when a further item is to be added.

2 Contacts list*

You can make a phone call from the Phone Book, or edit the Phone book.

3 Keypad screen

Use to type a phone number.

4 Edit*

Use to edit the Contacts list.

* When you connect two Hands-Free Phones, the information of the Bluetooth device set to Primary is displayed.

Answering a Call

Incoming calls are announced by the received call ring tone and a displayed message (PHONE No., etc.).

1 An incoming call triggers the ringtone and an incoming call display.

Incoming call notification screen

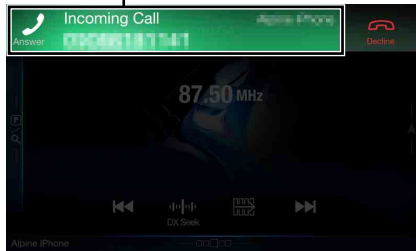

2 Touch incoming call notification screen. The call starts.

Call info area

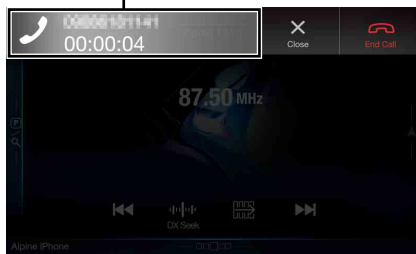

- You can also start the call by pressing the **↵ (PHONE)** button.
- During a call, the audio for the current mode on the unit is muted. After calling, playback will resume.
- When the caller's number is transmitted to the system, if the caller's name is stored in the phone book, the name is displayed. If the name is not stored, the number is displayed. When neither the name or the number is unavailable, "Unknown" is displayed.
- Touch **[Decline]** to reject an incoming call.
- Touch the call info area or press the **↵ (PHONE)** button during a phone call to switch to the Phone Operation screen. Then you can adjust the speech volume, etc. For details, see "Operations During a Conversation" (page 75).
- Touch **[X]** during a conversation to hide the call info area. To display it again, Touch or swipe downward on **[Call info area]** on the upper part of the screen.
- During an incoming call or a conversation on the Primary (Secondary) Hands-Free Phone, if there is an incoming call on the Secondary (Primary) Hands-Free Phone, you cannot answer the call on the Secondary (Primary) Hands-Free Phone without first ending the call on the Primary (Secondary) Hands-Free Phone.

Hanging up the Telephone

1 Touch **[End Call]**. The call finishes.

Call Waiting Function

If a call comes in from another phone during a call, a notice is displayed on the screen. This function can only be used if the connected mobile phone has a call waiting function service included.

Second incoming call during a conversation in the call info area

Second incoming call notification screen

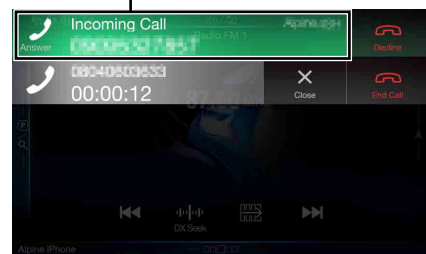

By touching the second incoming call notification screen, you can put the current call on hold and answer the second call.

Call On Hold screen

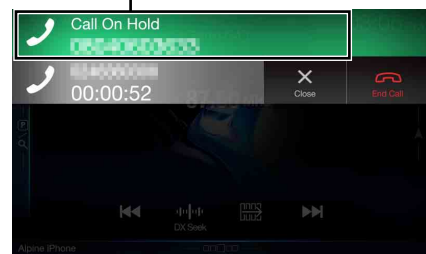

- To switch between calling parties, touch the on-hold screen, or press the **↵ (PHONE)** button.
- To finish a call, touch **[End Call]**.

Second incoming call during a conversation in the Phone Operation screen

- The display or operation may differ depending on the connected mobile phone or the caller's mobile phone.

Second incoming call notification screen

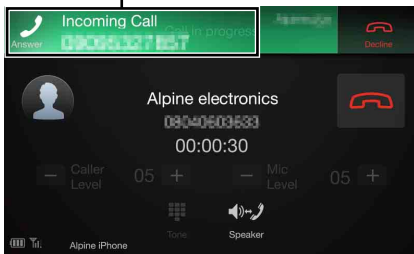

By touching the second incoming call notification screen, you can put the current call on hold and answer the second call.

Call On Hold screen

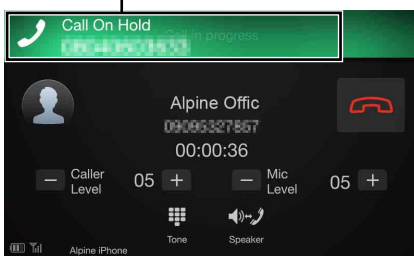

- To switch between calling parties, touch the on-hold screen, or press the **(PHONE)** button.
- To finish a call, touch **[End Call]**.
- This unit supports only the Call Waiting function of a mobile phone. The second call function and three-way calling function of a mobile phone cannot be operated from this unit. Also the screen display may malfunction.

Calling

Calling by Favourite Function

You can make a phone call using the Short Cut function of numbers that have been registered in Favourite. For details, see "Favourite Function" (page 22).

- Press and hold the **(Favourite)** button for at least 2 seconds.

The Favourite screen is displayed.

Favourite screen

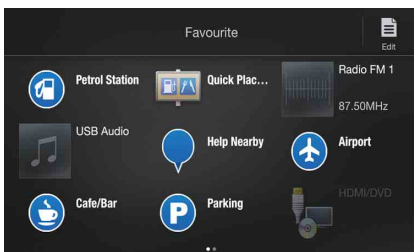

- Touch the **Short Cut** icon.

A contact's name, phone number, and a confirmation message of the phone number are displayed.

- Touch **[Call]**.

The phone call is started.

Making a phone call using the Phone Menu

Making a phone call from the Recent Events list

- Touch **[Recents]** to change to the Recent Events list screen.

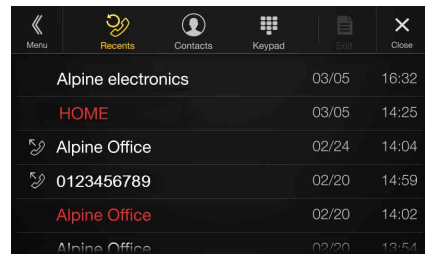

Dialled history:

[Recents] Names or Numbers/Date

Received history:

Names or Numbers/Date

Missed Incoming history:

[Recents] Names or Numbers/Date

- Touch the name of the contact you want to call.

The Detail info screen is displayed.

- Touch **[Call]**.

The phone call is started.

Calling from the Contacts list (Phone Book)

- Touch **[Contacts]** to change to the Contacts list screen.

- Touch the name of the contact you want to call.

The Phone Operation screen is displayed.

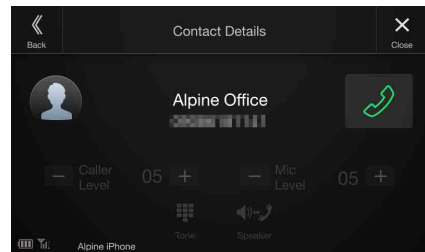

- Touch **[Call]**.

The phone call is started.

Entering a Phone Number to Make a Call

1 Touch [Keypad] (Keypad).

The number input screen (Keypad) appears.

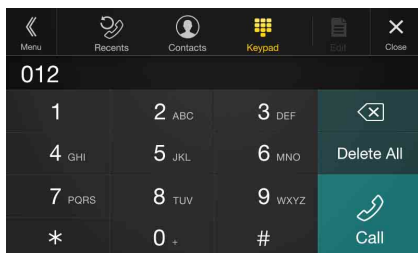

Touch [Delete] to delete an entered number.

Touch [Delete All] to delete all entered numbers.

2 Enter the phone number you wish to call.

- You can enter up to 31 digits.

3 Touch [Call] (Call).

A confirmation message of the phone number appears.

4 Touch [Call].

The phone call is started.

Using Voice Recognition function

You can use Siri function of your iPhone or make a telephone call by using voice operation of your smartphone.

Using Siri

You can use the Siri function of your iPhone. To use this function, set the Siri setting of your iPhone to ON.

- Connect your iPhone to the unit via Bluetooth, then set to "Hands-free" or "Both" (page 28).
- The available functions differ depending on the connected iPhone.
- Siri and other streaming services are enabled by connecting to compatible smartphones that are able to receive data. Please ensure that cellular data and/or Wi-Fi is turned on in the smartphone to enjoy these features.
- Extensive use of Siri or other streaming services may increase your phone's data usage. Please check with your phone company to ensure you have an appropriate Data plan.

1 Press the or VOICE button.

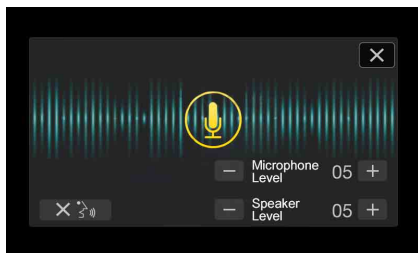

The Voice Control mode screen is displayed.

2 Speak into the microphone supplied with this unit.

- If no speech is detected, the unit may pause depending on version of the connected iPhone. In that case, touch the microphone icon [] in the centre of the Voice Control mode screen. You can continue to use the Voice Control mode.

3 To finish the Voice Control mode, touch [X] or press the or VOICE button.

- Depending on the iPhone, the Siri function may finish automatically.

Adjusting the volume

Adjust the speaker/microphone volumes in Voice Control mode.

Perform the same procedure to adjust the speaker/microphone volumes of hands-free phone.

Touch [–] or [+].

Adjust the speaker and microphone volumes.

Stopping input to the microphone

If the surrounding sound (road noise, etc.) is loud, you may wish to cut input to the microphone for 3 seconds.

Touch [X].

Voice Dial Function

You can make a telephone call by using voice operation.

- Connect your smartphone to the unit via Bluetooth, then set to "Hands-free" or "Both" (page 28).

1 Press the or VOICE button.

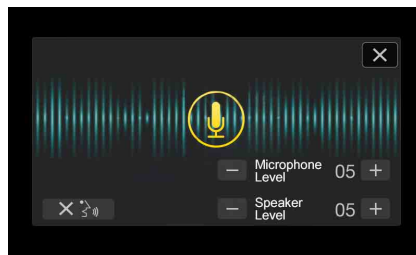

The Voice Dial mode screen is activated.

2 Say the telephone number* or name* you want to call, into the microphone.

- * The number and name depend on the voice dial information stored in the smartphone.

3 To finish the Voice Dial mode, touch [X] or press the or VOICE button.

- You can perform this operation only when a voice dial compatible smartphone is connected.
- The Voice Dial function performance depends on the recognition range of the smartphone and mounting location of the microphone. Note when the microphone is mounted.
- Voice dial operation depends on the function being available on the smartphone. For details, refer to the owner's manual of the smartphone.
- Depending on the smartphone, the Voice Dial operation may finish automatically.

Adjusting the volume

Adjust the speaker/microphone volume in Voice Dial mode. Perform the same procedure to adjust the speaker/microphone volume of hands-free phone.

Touch [–] or [+].

Adjust the speaker and microphone volumes.

Stopping input to the microphone

If the surrounding sound (road noise, etc.) is loud, you may wish to cut input to the microphone for 3 seconds.

Touch [X] [🔊].

Operations During a Conversation

Phone Operation screen

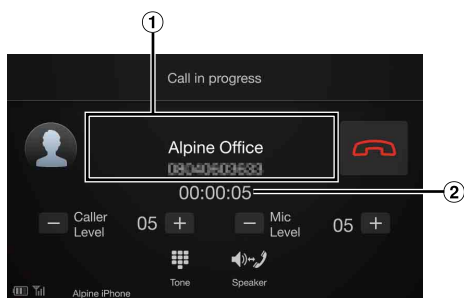

- 1 Name and phone number
 - If registered with a Group, the Group Name is also displayed. Although, depending on the connected mobile phone, it may not be displayed.
- 2 Conversation time

Adjusting the Speech Volume

You can adjust Caller Level and Mic. Level (Microphone Level) during a phone call.

Touch [–] or [+].

You can adjust the volume in 11 levels.

Changing the Voice Output

The voice output for calls is switchable between car speakers and the mobile phone speaker.

Touch [🔊] (Speaker).

- Depending on the mobile phone, this operation may not be possible.

DTMF (Touch-Tone) Function

Transmits a DTMF (Touch-Tone) during a call.

1 Touch [🔑] (Tone).

The number input screen (Keypad) appears.

2 Input number.

- You can transmit a Touch-Tone signal during a call.

Phone Book Function

Phone Book screen example

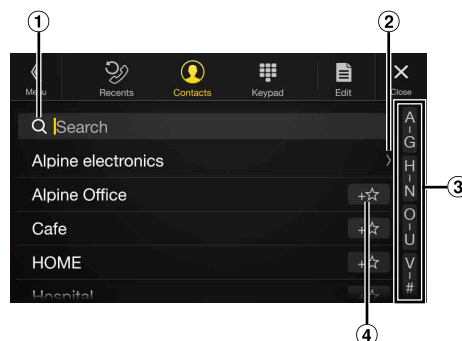

- 1 Use to search by directly inputting a name or phone number with the Keypad.
For details, see “How to Input Characters and Numbers (Keypad)” (page 21).
- 2 Displayed when multiple phone numbers are registered.
Touch [>] to display the registered phone number list.
- 3 Use to narrow down your search for names, etc.
For details, see “Alphabet Search Function” (page 63).
- 4 Touch [+★] to register as Favourite.

Synchronising the Phone Book

You can synchronise the system's phone book with the mobile phone's phone book.

1 Touch [📄] (Edit).

2 Touch [Download].

3 Touch [SYNC].

Synchronisation of the phone books starts.

- You can store up to 1,000 registered name in the phone book.
- You can store up to 5 phone numbers by one person's name.

Adding the Phone Book

1 Touch [📄] (Edit).

2 Touch [Download].

3 Touch [Add].

Stays on standby for connection of the mobile phone.

- Touch [Cancel] to cancel the standby mode.

4 The mobile phone accesses this unit and then transfers the phone book from the mobile phone to this unit.

- Mobile phone connection is cancelled while the phone book is being transferred.

Deleting the Phone Book Entries

Deleting One Entry from the Phone Book

- 1 Touch [Edit] (Edit).
The confirmation screen is displayed.
- 2 Touch the checkbox [] of the contact name (or phone number) you want to delete. A tick [] appears in the checkbox.
• You can choose up to 10 names and numbers at a time.
- 3 Touch [Delete].
The confirmation screen is displayed.
If multiple phone numbers are registered, they are all deleted.
- 4 Touch [OK].
The selected number is deleted.

Deleting All Entries from the Phone Book

- 1 Touch [Edit].
The confirmation screen is displayed.
- 2 Touch [Delete All].
The confirmation screen is displayed.
- 3 Touch [OK].
All entries of the phone book are deleted.

Searching in the Phone Book

You can make a call using the phone book search function.

- 1 Touch [Search].
The Input User Name screen (Keypad) is displayed.
 - 2 Input the string of letters of the name that you want to search, then touch [OK].
A list of names beginning with the string of letters you entered is displayed.
 - 3 Touch the name you want to call.
The Phone Operation screen is displayed.
 - 4 Touch [Call].
The phone call is started.
- For details of how to input characters using the keypad, see "How to Input Characters and Numbers (Keypad)" (page 21).
 - If there are fewer than five registered items in the phone book, you cannot use the phone book search function.

Bluetooth Audio

If a Bluetooth compatible mobile phone, portable player, etc. is connected by wireless, you can play back a song (operation is controllable from the unit).

- Operation may vary, depending on the Bluetooth compatible device.

Bluetooth Audio main screen example



Function mode



- 1 Current track no./Total song no.
- 2 Artist title
- 3 Song title
- 4 Album title
- 5 Elapsed time
- 6 Touch or swipe to the right to use the Quick Search mode and Full Search mode.

Quick Search mode screen example

Swipe vertically in the list to change pages.



- 7 Full Search button
Swipe to the right when using Full Search mode.
- The displayed onscreen buttons may differ depending on the AVRCP version.
 - Song title/Artist title/Album title/Elapsed time do not display for AVRCP Ver. 1.0.
 - To play back audio, a mobile phone or a portable player conforming to A2DP (Advanced Audio Distribution Profile) or AVRCP (Audio/Video Remote Control Profile) is required.
Not all functions work with all devices.
 - During a call, sound on the Bluetooth audio source is paused.

Compatible AVRCP versions: 1.0, 1.3, 1.4, 1.5

- Available functions may differ depending on the AVRCP version.

Playback

1 Press the (AUDIO) button to select Bluetooth Audio mode.

The display shows the Bluetooth Audio mode screen.

- You can also select and change the source in the Menu screen (page 19) or the Favourite screen (page 22).

2 Touch [] or [] to select the desired track (file).

Returning to the beginning of the current file:

Touch [].

Fast backward the current file:



Touch and hold [].

Advance to the beginning of the next file:

Touch [].

Fast forward the current file:

Touch and hold [].

- The ,  buttons provide the same functions above.

3 To pause playback, touch [/III].

Repeat Play

Available for AVRCP Ver. 1.3, 1.4 and 1.5 only.

1 Touch [].

The Repeat mode select pop up screen is displayed.

- [] displays the currently selected mode.

2 Select your desired Repeat mode.

The selected Repeat mode changes the button.

All Track : Once all of the songs have finished playing, play back is repeated, starting with the first song.

Group : Only files in a group are repeatedly played back.

Single Track : Only the track currently playing is repeatedly played back.

Off : Repeat mode Off.

- Operations may differ depending on the connected Bluetooth compatible device.

Random Play

Available for AVRCP Ver. 1.3, 1.4 and 1.5 only.

1 Touch [].

The Random Play mode select pop up screen is displayed.

- The [] button displays the currently selected mode.

2 Select your desired Random Play mode.

The selected Random Play mode changes the button.

All Track : All songs in the BLUETOOTH compatible devices are played back in random sequence. Any one song does not play back again until all songs have been played back.

Group : A Group is selected randomly and songs in the Group are played back in order. After all songs are played in the Group, the next Group is selected randomly.

Off : Random mode Off.

- Operations may differ depending on the connected Bluetooth compatible device.

Search Function

Available for AVRCP Ver. 1.4 and 1.5 only.

The displayed list differs with the connected Bluetooth device.

You can search for your desired song by using one of two modes; the Quick Search mode and the Full Search mode.

Quick Search mode

Touch your desired Group name or File name.

The selected Group*¹ or file is played back.

*¹ The first file in the selected Group is played back.

- To switch into Quick Search mode, see ⑥ in “Bluetooth Audio main screen example” (page 76).

Full Search mode

Touch your desired Group name*² or File name.

When you select a File name, the selected song is played.

When you select a Group name, repeat the same procedure to select another Group name or File name.

*² When you touch the [] by a Group name, the unit plays from the first song in the Group.

- To switch into Full Search mode, see ⑦ in “Quick Search mode screen example” (page 76).
- To switch the displayed list or return to the previous page in the List screen, see “About Basic Operation for List Screen” (page 17).

Connecting a Bluetooth Device

Registering a Bluetooth device in the unit enables automatic connection. If it does not connect automatically, run through the connection procedure again.

- 1 Touch [📶] (Phone Setting).**
The Device Setting select pop up screen is displayed.
- 2 Touch [Reconnect].**
Bluetooth connection will start.

Disconnecting the Bluetooth Connection

- 1 Touch [📶] (Phone Setting).**
The Device Setting select pop up screen is displayed.
- 2 Touch [Disconnect].**
The Bluetooth connection is disconnected.

Changing the connecting Bluetooth Device

If multiple Bluetooth devices are registered in this device, you can change the connection among the registered devices.

- 1 Touch [📶] (Phone Setting).**
- 2 Touch [Change Phone].**
- 3 Touch [🎵] (Audio) or [📞] (Hands-free) of the selected device.**
The connection will transfer to the selected device.

Auxiliary Device (Optional)

Operating Auxiliary Devices (Optional)

To operate devices connected to the AUX terminals of the unit, follow the procedure described below.

- Set AUX to “On.” See “AUX Setup” (page 43).
- Depending on the connected unit, the onscreen buttons may not work, or their operation may differ.

⚠ WARNING

It is dangerous (and illegal in many states) for the driver to watch TV/video while driving the vehicle. The driver may be distracted from looking ahead and an accident could occur.

Install the unit correctly so that the driver cannot watch TV/video unless the car is stopped and the parking brake is applied.

If the unit is not installed correctly, the driver will be able to watch TV/video while driving and may be distracted from looking ahead and cause an accident. The driver or other people could be severely injured.

Press the **🎵 (AUDIO)** button to select Auxiliary (AUX)* mode. The display shows the Auxiliary (AUX) mode screen.

* The name which is given as the mode name in “Setting the Auxiliary (AUX) Name” (page 43) is displayed.

- For your safety, video is not displayed and only audio can be heard while driving.
- You can select and change the source in the Menu screen (page 19) or Favourite screen (page 22).
- For details on the connected auxiliary device, refer to its owner’s manual.

AUX Operation Screen Display During Video File Playback

Touch the screen.

The Auxiliary (AUX) operation screen is displayed.

- The operation screen changes to the visual screen in the Auxiliary (AUX) mode for 5 seconds after an operation has been performed. To hide the Auxiliary (AUX) operation screen, touch the video display area.

Operating an AUX, AUX DVD, GAME or USB Player

- Example for AUX, AUX DVD, GAME, USB Player mode display

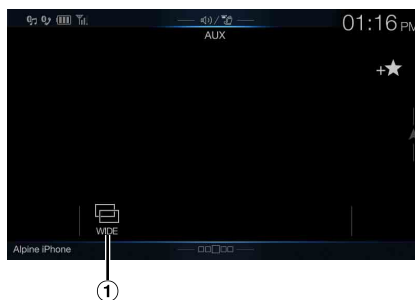

- 1 **[WIDE]** (Display Mode)
For details, see “Switching Display Modes (During Video File Play Back)” (page 60).
 - You cannot operate them while driving.

Operating an External DVD Player

- External DVD player display example

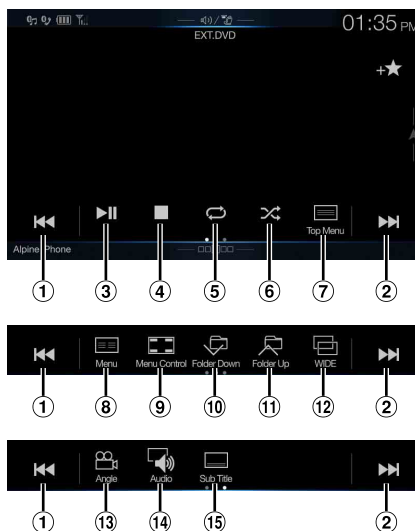

- 1 **[⏮]**
Touch the switch to go back to the beginning of the current chapter/track/file. Touch the switch once more to find the beginning of the previous chapter/track/file. Touch and hold to fast reverse.
- 2 **[⏭]**
Touch the switch to advance to the beginning of the next chapter/track/file. Touch and hold to fast forward.
- 3 **[⏸]**
Switches between play and pause.
- 4 **[■]**
Touching during play initiates a pre stop. Touching again stops play.
- 5 **[↺]**
Starts/Stop repeat play.
- 6 **[↻]**
Starts/Stop M.I.X. play.

- ⑦ [≡] (Top Menu)
Calls up the Top Menu screen.
- ⑧ [≡] (Menu)
Calls up the Menu screen.
- ⑨ [☰] (Menu Control)*
Calls up the menu operation mode.
- ⑩ [⇩] (Folder Down)
Switches the programme/playlist/folder down.
- ⑪ [⇧] (Folder Up)
Switches the programme/playlist/folder up.
- ⑫ [☰] (Display Mode)*
You can set the Display Mode. For details, see "Switching Display Modes (During Video File Play Back)" (page 60).
- ⑬ [📐] (Angle)
Switches angle.
- ⑭ [🔊] (Audio)
Switches audio.
- ⑮ [☰] (Sub Title)
Switches sub titles.

■ Menu operation mode screen example

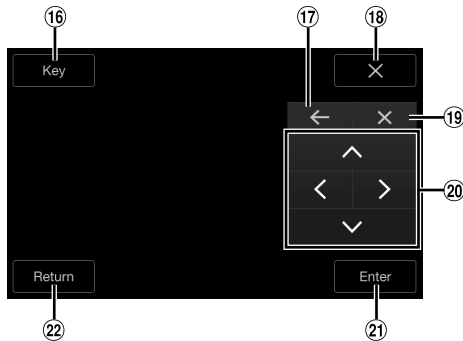

- ⑬ [Key]
The menu operation mode will be displayed.
- ⑭ [←], [→]
Moves key panel location.
- ⑮ [X]
Closes menu operation mode.
- ⑯ [X]
Closes key panel.
- ⑰ [↑], [↓], [←], [→]
Moves menu cursor.
- ⑱ [Enter]
Determines the selected item.
- ⑲ [Return]
Returns to the previous item/screen.

* You cannot operate them while driving.

Operating an External DVD Changer

The DVD-CHG operation mode screen and the Menu operation mode screen are the same as the external DVD player operation screen. See "Operating an External DVD Player."

■ External DVD changer screen example



- ① [Disc1]-[Disc6]
Selects a Disc.
 - Touch the left side of the operation screen or swipe the operation screen to the right to display the Disc selection screen.

Operating the Mobile Digital TV Receiver (DVB-T)

■ Menu operation mode screen example

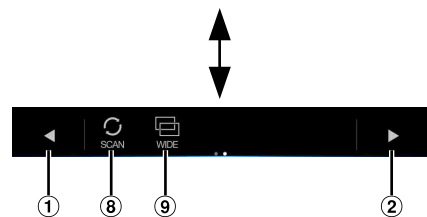
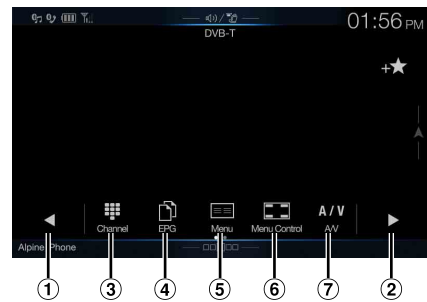

- ① [⇩]
Switches the Channel number / Favourite channel number down.
- ② [⇧]
Switches the Channel number / Favourite channel number up.
- ③ [📺] (Channel or Favourite)
Switches between the Channel mode and the Favourite channel mode.
- ④ [📺] (EPG)*
Call up the Electronic Programme Guide (EPG).
- ⑤ [≡] (Menu)*
Call up the menu screen.
- ⑥ [☰] (Menu Control)*
Call up the menu operation mode.
- ⑦ [A / V] (A/V)
Switches the source.
- ⑧ [🔄] (Scan)
Touch the switch to start the scan procedure.
- ⑨ [☰] (Display Mode)*
You can set the Display Mode. For details, see "Switching Display Modes (During Video File Play Back)" (page 60).

* You cannot operate them while driving.

- If the setting for “Setting Direct Touch Operation” (page 43) is set to “On”, the direct touch operation is possible. Directly touch operation switches displayed on the screen to operate. To display the operation screen, touch [Control].

Operating a TV

■ Menu operation mode screen example

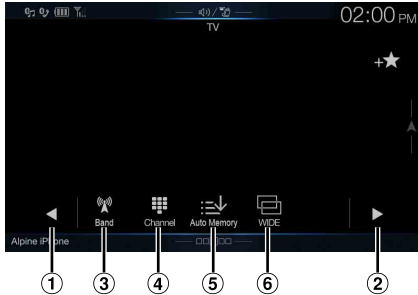

- ① [◀], [◀◀]
Switches the Channel number / Preset channel down.
- ② [▶], [▶▶]
Switches the Channel number / Preset channel up.
- ③ [📶] (Band)
Switches the band.
- ④ [📶] (Tune) (Channel or Preset or Manual)
Switches amongst Channel mode, Preset mode, and Manual mode.
- ⑤ [⏸] (Auto Memory)
The tuner automatically seeks and stores stations.
- ⑥ [📺] (Display Mode)*
You can set the Display Mode. For details, see “Switching Display Modes (During Video File Play Back)” (page 60).

* You cannot operate them while driving.

Camera Operation (Optional)

When an optional camera is connected, the view video of camera can be output to the monitor.

Front camera or Rear camera can be connected to this unit.

Make the Camera Select setting (Front, Rear or Other) according to your connected camera. For details, see "Setting the Camera Input" (page 44).

Front camera:

When the HCE-C257FD/HCE-C212FD is connected, conditions in front of the vehicle, such as objects, people and other hazards, can be seen.

Rear camera:

If an HCE-C127D/HCE-C157D/HCE-C252RD, etc., camera is connected, when the vehicle is reversed, the rear camera view (guide marks for vehicle width and available distance) is displayed automatically on the screen of this unit.

Other camera:

Set when connecting to a camera other than the Front camera or Rear camera, such as a room camera and side camera.

You can adjust the quality of the camera image.

Setting items: Brightness / Colour / Contrast
See "Visual Setup" (page 36).

Rear Camera Operation

Displaying the Rear Camera Image from the Menu screen

1 Press the MENU button.

The menu screen is displayed.



[Camera] button

- You can also display the menu screen by touching [^] on the lower part of the Audio source screen or by swiping upward.

2 Touch [Camera].

The Rear Camera view is displayed.

- Touch the screen while the camera image is being displayed, and touch [X] or [K] to return to the main source screen or previous screen.
- You can perform a Guide Adjustment. For details, see "Adjusting the Rear/Front/Side Camera Guide" (page 45).

Displaying the rear view video while the car is in reverse

1 Shift the gear lever to the reverse (R) position.

The rear view image is displayed while the car remains in reverse.

2 If you shift the gear lever to a position other than reverse (R), the monitor returns to the previous screen.

- Never depend solely on the camera when backing up. Always turn and look and only use the camera for additional assistance.
- This function is effective when the reverse wire is properly connected.
- You can perform a Guide Adjustment. For details, see "Adjusting the Rear/Front/Side Camera Guide" (page 45).

Switching the Image Pattern for the Rear Camera

If the camera has a view switch function, the Direct Change switch is displayed.

1 Touch the screen when the image from the rear camera is displayed.

The operation screen is displayed on the screen.

- After a 5-second time-out, the operation screen returns to the camera display screen.

2 Touch [Back], [Panorama], [Corner] or [Top].

The image pattern changes.

[Back]: Rear View

[Panorama]: Panorama View

[Corner]: Corner View

[Top]: Ground View

- For detailed information about image patterns, see the camera Owner's Manual.
- You can perform a Guide Adjustment. For details, see "Adjusting the Rear/Front/Side Camera Guide" (page 45).

Guide Display ON/OFF Setting

1 Touch the screen when the image from the camera is displayed.

The operation screen is displayed on the screen.

- After a 5-second time-out, the operation screen returns to the camera display screen.

2 Touch [Guide Off] on the Rear camera display screen.

The guide disappears, and then the [Guide Off] switch changes to [Guide On].

3 Touch [Guide On] to turn on the guide.

Adjusting the Caution Display Location

1 Touch the screen when the image from the camera is displayed.

The operation screen is displayed on the screen.

- After a 5-second time-out, the operation screen returns to the camera display screen.

2 Touch [⚠ Caution].

- For each touch, the caution location moves to the top or bottom of the screen.

About the Rear Camera Guide

To display the guide, set "Guide Display ON/OFF Setting" (page 82) to On. Also, to adjust the guide, see "Adjusting the Rear/Front/Side Camera Guide" (page 45). You can also turn off the guide in the Rear camera display screen.

■ Indication mark meaning

When the car is put into reverse gear, the monitor switches to the rear view camera image. Guides appear to help visualise the car's width and distance from the rear bumper.

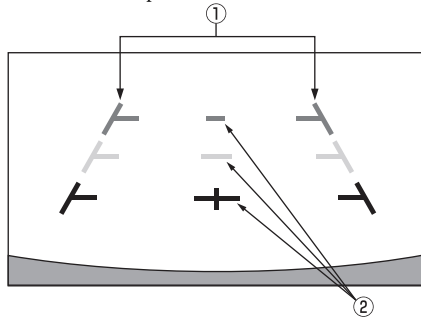

① Car width extension marks (red, yellow and green in order of distance)

If properly calibrated, the marks indicate the car's width. This helps guide the car's path when backing up in a straight line.

The marks represent the distance from the rear of the car (from the rear end of the bumper).

- The marks do not move in synchronisation with the steering wheel.
- Set the marks to suit the car's width.

② Distance guidance marks

The marks represent the distance from the rear of the car (from the rear end of the bumper).

- The marks do not move in synchronisation with the steering wheel.
- We recommend that you measure the actual distance to the marks when parked on a level surface.
- Depending on the condition of the car or road surface, the range of vision may vary.
- The camera has a limited range of vision. Objects at extreme angles to the camera (e.g. under the bumper or at opposite ends of the bumper) may not be in the its field-of-vision.
- The rear camera image may have a tint which is different from the actual surroundings.
- Depending on the car, the guidance may deviate to the right or left. This is not a malfunction.

■ Distance guidance mark

The distance guides represent the ground level distance from the rear bumper. It is difficult to accurately estimate the distance to objects above ground level.

In the following example, the distance to A is 0.5 m and the distance to B is 1 m.

<Screen>

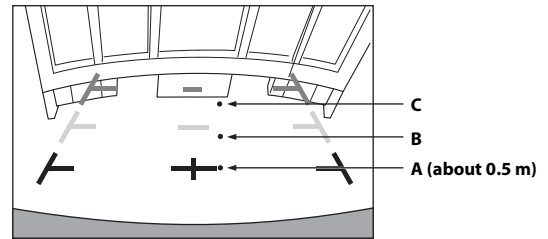

<Positions of A, B and C>

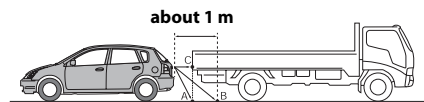

In the screen, according to the distance guidance marks, the truck seems to be parked about 1 m away (at the position B). In actual fact, however, if you reversed to position A, you would collide with the truck.

In the screen, positions A, B and C seem to be located in order of proximity. However, in actual fact, the position A and C are the same distance, and B is farther away than positions A and C.

- The car width extension mark represents the distance to the road surface. The distance to an object on the road is not accurately represented by the guides.

Error between the screen and the actual road surface

In the following conditions, errors are produced between the screen guidance and the actual road surface. (The illustrations represent a case when the camera is installed in the standard position.)

■ When there is a steep upward slope behind the car (example)

<Screen>

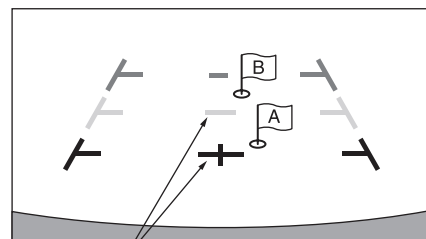

Distance guidance marks

<Situation of the car>

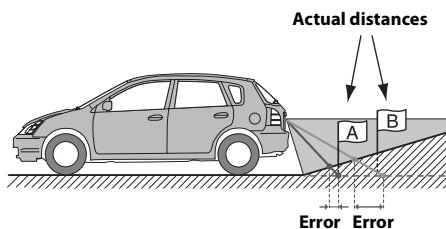

The distance guidance mark represents the distance to a flat road surface. Therefore in the case of an upward slope behind the car, the distance guides are displayed closer to the rear bumper than the actual distance. For example, if there is an obstacle on the upward slope, it may appear farther away than its actual position.

Also, an error may occur between the guidance and the actual path of the car on the road surface.

■ When there is a steep downward slope behind the car (example)

<Screen>

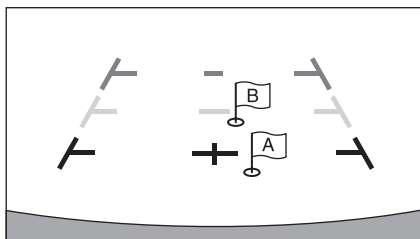

<Situation of the car>

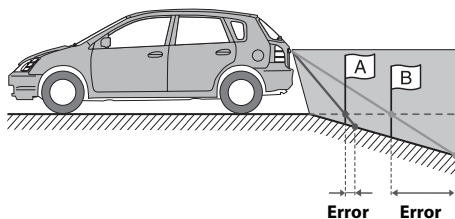

In the case of a downward slope behind the car, the distance guides are displayed farther from the rear bumper than the actual distance.

If there is an obstacle on the downward slope, it seems closer than its actual position.

Also, an error may occur between the guidance and the actual path of the car on the road surface.

Front Camera Operation

Displaying the Front Camera image from the Menu screen.

1 Press the MENU button.

The menu screen is displayed.



[Camera] button

- You can also display the menu screen by touching [\wedge] on the lower part of the Audio source screen or by swiping upward.

2 Touch [Camera].

The Front Camera view is displayed.

- Touch the screen while the camera image is being displayed, and touch [\times] or [\ll] to return to the main source screen or previous screen.
- You can perform a Guide Adjustment. For details, see "Adjusting the Rear/Front/Side Camera Guide" (page 45).

Switching the Image Pattern for the Front Camera

If the camera has a view switch function, the Direct Change switch is displayed.

1 Touch the screen when the image from the front camera is displayed.

The operation screen is displayed on the screen.

- After a 5-second time-out, the operation screen returns to the camera display screen.

2 Touch [Panorama], [Corner] or [Top].

The image pattern changes.

[Panorama]: Panorama View

[Corner]: Corner View

[Top]: Ground View

- For detailed information about image patterns, see the camera Owner's Manual.
- You can perform a Guide Adjustment. For details, see "Adjusting the Rear/Front/Side Camera Guide" (page 45).

About the adjustment of guide display ON/OFF setting and adjustment of Caution display location

As with the rear camera, the front camera guide display ON/OFF setting and Caution display location can be adjusted. See "Guide Display ON/OFF Setting" (page 82) and "Adjusting the Caution Display Location" (page 82) for the operations.

Side Camera Operation

Displaying the Side Camera image from the Menu screen

- 1 **Press the MENU button.**
The menu screen is displayed.



[Camera] button

- You can also display the menu screen by touching [^] on the lower part of the Audio source screen or by swiping upward.

- 2 **Touch [Camera].**
The Side Camera view is displayed.

- Touch the screen while the camera image is being displayed, and touch [X] or [<<] to return to the main source screen or previous screen.
- You can perform a Guide Adjustment. For details, see "Adjusting the Rear/Front/Side Camera Guide" (page 45).
- If you connect a Side Camera using the optional Multi Camera Interface module, you can display the Side camera image using the [Camera] button only when you set "Setting a Default Camera" (page 46) to "Side". If you connect a Rear Camera and Front Camera at the same time, touch [Rear] or [Front] in the Rear Camera image to switch the Camera image.

Switching the Image Pattern for the Side Camera

If the camera has a view switch function, the Direct Change switch is displayed.

- 1 **Touch the screen when the image from the side camera is displayed.**

The operation screen is displayed on the screen.

- After a 5-second time-out, the operation screen returns to the camera display screen.

- 2 **Touch [Rear] or [Front].**
The image pattern changes.

Rear: Vehicle Rear view

Front: Vehicle Front view

- For detailed information about image patterns, see the camera Owner's Manual.
- You can perform a Guide Adjustment. For details, see "Adjusting the Rear/Front/Side Camera Guide" (page 45).

About Vehicle Interlock Function

Communication between your vehicle and the unit allows you to set and display various functions of your vehicle.

Available functions differ depending on your vehicle. For details, refer to your vehicle's instruction manual.

Available Main Functions

- You can check the air conditioner settings on the Climate screen.*
- You can check for obstacles on the Parking Sensor screen.*
- You can adjust various settings for your vehicle from the unit.

* When the Interruption function is set to "On," the screen changes automatically when you adjust the air conditioner or the unit detects an obstacle. For details on the Interruption setup, see "CAN-I/F Setup" (page 46).

Vehicle Info mode

You can check the Climate screen and Park sensor screen from the Menu screen of the unit. For how to display the Menu screen, see "About the Menu Screen" (page 19).

1 Touch [V] (Vehicle Info) on the Menu screen.

The Vehicle Info mode screen is displayed.

2 Touch the desired tab on the upper part of the screen.

The Climate screen or Park sensor screen is displayed.

- By touching [Car Setting] (Car Setting) on the Vehicle Info mode screen, you can use the unit to turn various settings related to your vehicle On/Off, set display formats, etc. For details on what functions you can set, refer to your vehicle's instruction manual.

Function Screen Examples

The screens that can be displayed on this unit differ, depending on the type of vehicle.

Climate screen example

The Climate screen turns on when you adjust the air conditioning in your vehicle. The icons of adjusted items are high lighted.



Parking Sensor screen

The Parking sensor screen turns on when the front or rear sensor on your vehicle detects an obstacle within a certain distance.

Parking Sensor Full screen example

When the front or rear sensor detects an obstacle within a certain distance, the Parking Sensor screen is displayed, and the indicator (1 - 8) that corresponds with that area lights up.

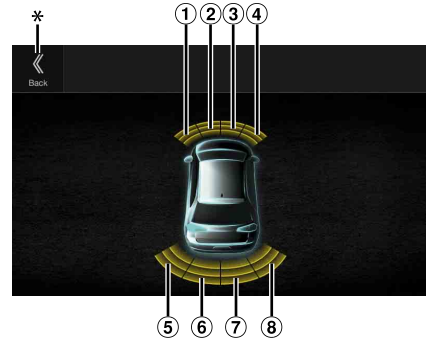

Indicator colours when an obstacle is detected.

Red: close distance
Orange: medium distance
Yellow: long distance

- Depending on the speed of the vehicle, when moving faster than a certain speed, the Parking Sensor screen may not be displayed.
- Vehicles that do not have the obstacle detection sensor cannot use this function.

* [Back] is displayed only when the Front camera or Rear camera is interlocked.

Parking Sensor Camera interlock screen example (Rear camera)

You can check for obstacles through an interlocked camera image by connecting a Front or Rear Camera.

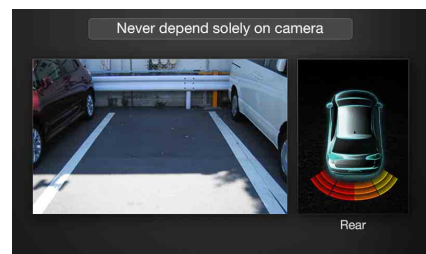

- Touch the Camera image area to switch to the Camera full screen. (While displaying the Camera full screen, touch the Camera screen, then touch [Sensor] to return to the Parking Sensor Camera interlock screen.)
- Touch the car icon to switch to the Parking sensor full screen. (Touch [Back] on the Parking Sensor full screen to return to the Parking Sensor Camera interlock display.)
- To use this function, set the Camera Select setting to "Front/Other" or "Rear." For details, see "Setting the Camera Input" (page 44).

Information

Product Software Update

This product use software that can be updated through a USB flash drive. Download the software from the Alpine website and update the product using the USB flash drive.

Updating this product

Check the Alpine website for details on updating.

<http://www.alpine-europe.com>

Important information on the software

About the software licence of the product

The software installed in the product contains open-source software. See the following Alpine website for details on the open source software.

<http://www.alpine.com/e/oss/download>

About the Supported Formats

- For the list of video formats supported from a USB flash drive, see "About USB Video format" (page 60).

About MP3/WMA/AAC/FLAC



CAUTION

Except for private use, duplicating audio data (including MP3/WMA/AAC/FLAC data) or distributing, transferring, or copying it, whether for free or for a fee, without permission of the copyright holder is strictly prohibited by the Copyright Act and by international treaty.

What is MP3?

MP3, whose official name is "MPEG Audio Layer 3," is a compression standard prescribed by the ISO, the International Standardisation Organisation and MPEG which is a joint activity institution of the IEC.

MP3 files contain compressed audio data. MP3 encoding is capable of compressing audio data at extremely high ratios, reducing the size of music files to as much as one-tenth their original size. This is achieved while still maintaining near CD quality. The MP3 format realises such high compression ratios by eliminating the sounds that are either inaudible to the human ear or masked by other sounds.

What is WMA?

WMA, or "Windows Media™ Audio," is compressed audio data. WMA is similar to MP3 audio data.

What is AAC?

AAC is the abbreviation for "Advanced Audio Coding," and is a basic format of audio compression used by MPEG2 or MPEG4.

What is FLAC?

FLAC (Free Lossless Audio Codec) is an audio file codec for lossless compression, developed and offered as open source software. Codecs with lossy compression forms, such as MP3 and AAC, reduce part of the data to improve compression efficiency. However, FLAC can reconstruct compressed data to be an identical copy of the original data by performing lossless compression. The compression ratio of FLAC is about 50%.

Method for creating MP3/WMA/AAC/FLAC (USB Flash drive) files

Audio data is compressed using software with MP3/WMA/AAC/FLAC (USB Flash drive) codecs. For details on creating MP3/WMA/AAC/FLAC (USB Flash drive) files, refer to the user's manual for that software.

MP3/WMA/AAC/FLAC (USB Flash drive) files that are playable on this device have the file extensions.

MP3: "mp3"

WMA: "wma"

AAC: "m4a"

FLAC: "flac"/"fla"

WMA is not supported for the following files, Windows Media Audio Professional, Windows Media Audio 10 std or Windows Media Audio 10 Pro Lossless.

There are many different versions of the AAC format. Confirm that the software being used conforms to the acceptable formats listed above. It's possible that the format may be unplayable even though the extension is valid.

Playback of AAC files encoded by iTunes is supported.

Supported playback sampling rates and bit rates

MP3 (USB Flash drive)

Sampling rates: 48 kHz, 44.1 kHz, 32 kHz, 24 kHz, 22.05 kHz, 16 kHz, 12 kHz, 11.025 kHz, 8 kHz

Bit rates: 8 - 320 kbps

WMA (USB Flash drive)

Sampling rates: 48 kHz, 44.1 kHz, 32 kHz, 22.05 kHz, 16 kHz, 11.025 kHz, 8 kHz

Bit rates: 48 - 320 kbps

AAC (USB Flash drive)

Sampling rates: 48 kHz, 44.1 kHz, 32 kHz, 24 kHz, 22.05 kHz, 16 kHz, 12 kHz, 11.025 kHz, 8 kHz

Bit rates: 16 - 320 kbps

FLAC (USB Flash drive)

Sampling rates: 96kHz, 88.2kHz, 48kHz, 44.1kHz, 32kHz, 24kHz, 22.05kHz, 16kHz, 8kHz

Channel number: 1ch, 2ch

This device may not play back correctly depending on sampling rates.

ID3 tags/WMA tags

This device supports ID3 tag v1.0, v1.1, v2.2, v2.3, v2.4, and WMA tag Ver.1.x. If tag data is in an MP3/WMA/AAC file, this device can display the title (track title), artist name, and album name ID3 tag/WMA tag data.

For non-supported characters, "?" is displayed.

The number of characters may be limited, or not correctly displayed, depending on the tag information.

Playing back MP3/WMA/AAC/FLAC

MP3/WMA/AAC files are prepared, then written to a USB flash drive.

- Maximum numbers of playable files/folders
USB Flash drive: 10,000 files/folders (including Root Folder)
- Largest playable file size: 512 MB

Playback may not be performed if a disc exceeds the limitations described above.

If a file/folder name is long, the maximum possible number of files may decrease.

- Both Audio and Video files are counted if their formats are playable on this unit.

Media supported

The media that this device can play back a USB flash drive.

Corresponding File Systems

This device supports FAT 16/32.

The maximum nested folder depth is 8 (including the root directory). File names are limited to 256 characters (including the extension).

Valid characters for folder/file names are letters A-Z (all caps), numbers 0-9, and '_' (underscore).

Order of files

Files are played back in the order that the writing software writes them to the disc. Therefore, the playback order may not be what's expected. Verify the writing order in the software's documentation. The playback order of the folders and files is as follows. (The following numbers may differ from actually displayed numbers.)

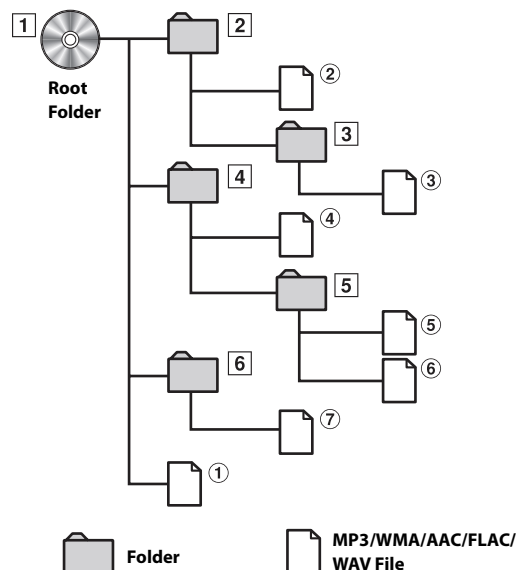

Terminology

Bit rate

This is the "sound" compression rate specified for encoding. The higher the bit rate, the higher the sound quality, but also the larger the files.

Sampling rate

This value shows how many times per second the data is sampled (recorded). For example, music CDs use a sampling rate of 44.1 kHz, so the sound is sampled (recorded) 44,100 times per second. The higher the sampling rate, the higher the sound quality, but also the larger the volume of data.

Encoding

Converting music CDs, WAVE (AIFF) files, and other sound files into the specified audio compression format.

Tag

Song information such as track titles, artist names, album names, etc., written into MP3/WMA/AAC/FLAC (USB flash drive) files.

Root folder

The root folder (or root directory) is found at the top of the file system. The root folder contains all folders and files. It is created automatically for all burned discs.

In Case of Difficulty

If you encounter a problem, please turn the power off, then on again. If the unit is still not functioning normally, please review the items in the following checklist. This guide will help you isolate the problem if the unit is at fault. Otherwise, make sure the rest of your system is properly connected, or then consult your authorized Alpine dealer.

Basic

No function or display.

- Vehicle's ignition is off.
 - If connected according to the instructions, the unit will not operate with the vehicle's ignition off.
- Improper power lead connections.
 - Check power lead connections.
- Blown fuse.
 - Check the fuse on the battery lead of the unit; replace with the proper value if necessary.
- Internal micro-computer malfunctioned due to interference noise, etc.
 - Press the RESET switch with a ballpoint pen or other pointed article.

No sound or unnatural sound.

- Incorrect setting of volume/balance/fader controls.
 - Readjust the controls.
- Connections are not properly or securely made.
 - Check the connections and firmly connect.

Screen not displayed.

- Brightness/Contrast control is set at the minimum position.
 - Adjust the Brightness/Contrast control.
- Temperature in the vehicle is too low.
 - Increase the vehicle's interior temperature to operation temperature range.
- Connections to the Auxiliary Device are not securely made.
 - Check the connections and firmly connect.
- The Parking Brake Lead is not connected.
- The Parking Brake is not engaged.
 - Connect the Parking Brake Lead, then engage the Parking Brake.

Movement of displayed picture is abnormal.

- Temperature in the vehicle is too high.
 - Allow the vehicle's interior temperature to cool.

The optional remote control is inoperative.

- The remote control sensor setting of "Remote Sensor Setting" (page 47) is not set to this unit ("Front").
 - Set for "Front".

Radio

Unable to receive stations.

- No antenna, or open connection in the antenna cable.
 - Make sure the antenna is properly connected; replace the antenna or cable if necessary.

Unable to tune stations in the seek mode.

- You are in a weak signal area.
 - Make sure the tuner is in DX mode.
- If the area you are in is a primary signal area, the antenna may not be grounded and connected properly.
 - Check your antenna connections; make sure the antenna is properly grounded at its mounting location.
- The antenna may not be the proper length.
 - Make sure the antenna is fully extended; if broken, replace the antenna with a new one.

Broadcast is noisy.

- The antenna is not the proper length.
 - Extend the antenna fully; replace it if it is broken.
- The antenna is poorly grounded.
 - Make sure the antenna is grounded properly at its mounting location.
- The station signal is weak and noisy.
 - If above solution does not work, tune in another station.

USB Audio

Unit does not operate.

- Condensation.
 - Wait a while (about 1 hour) for the condensation to dry.

Picture is unclear or noisy.

- Vehicle's battery power is weak.
 - Check the battery power and wiring.
(The unit may malfunction if the battery power is under 11 volts with a load applied.)

Rear Seat Entertainment System

DVD sound is not being output from the rear monitor headphones.

- The external audio processor and DVD Player (DVE-5300) are optically connected.
 - Set the Audio Out of the DVD Player to "LPCM."

Navigation (X902D/X802D-U/INE-W710D only)

The Navigation cannot work properly.

- Reset Navigation system.
 - Turn the ignition key off, and then set to ON again.

If this Message Appears

Various messages are displayed on the screen during operation. In addition to the messages telling you the current status or providing guidance for the next operation, there are also the following error messages. If one of these error messages is displayed, carefully follow the instructions in the solution column.

System

If you are driving, please pull over before using this function.

- A setup operation, etc., was carried out while the vehicle was running.
 - Move the vehicle to a safe location, stop, and engage the parking brake, then carry out this operation.
-

USB current error.

- Abnormal current is run to the USB connector device.
 - Turn the ignition key off, and then set to ON again.
 - Attempt to connect another iPod/iPhone/USB Flash drive.
-

USB HUB is not supported.

- A USB flash drive with a hub is connected.
 - You cannot play back from a USB flash drive with a hub. USB hub connections are also not supported.
-

File Format not supported.

- A USB Video file that is not supported by this unit is selected.
 - Check if the video file is playable by seeing "About USB Video format" (page 60).
-

Audio/Visual

Connected USB device is not supported.

- An iPod/iPhone that is not supported by the unit is connected.
 - Connect an iPod/iPhone that is supported by the unit.
 - Reset the iPod.
 - A USB device that is not supported by the unit is connected.
 - Attempt to connect another USB flash drive.
 - Communication error.
 - Turn the ignition key off, and then set to ON again.
 - Check the display by reconnecting between the iPod/iPhone and the unit, using the iPod/iPhone cable.
 - Check the display by reconnecting between the USB flash drive and the unit.
 - Caused by the iPod/iPhone Software Version not being compatible with this unit.
 - Update the iPod/iPhone Software Version to be compatible with this unit.
 - The iPod/iPhone is not verified.
 - Change to another iPod/iPhone.
-

No data.

- There are no data in the iPod/iPhone.
 - Download data to the iPod/iPhone and connect to the unit.
 - There are no data in the USB flash drive.
 - Download data to the USB flash drive and connect to this unit.
-

Un-readable song was skipped.

- A copy-protected WMA file has been detected.
 - You can only play back non-copy-protected files.
 - A sampling rate/bit rate not supported by the unit is used.
 - Use a sampling rate/bit rate supported by the unit.
-

DAB Antenna error

- The DAB antenna cable is either damaged or not connected correctly to the product.
 - Check that the antenna cable is not kinked or otherwise damaged. Replace the antenna if necessary.
 - Abnormal current is run to the DAB Antenna.
 - Connect the antenna properly to a car with a 12 volt negative ground.
-

Bluetooth

Please connect Bluetooth audio device.

- The Bluetooth audio device was not connected correctly.
 - Check the settings for the unit and the Bluetooth audio device and reconnect.
-

Unable to download phonebook.

- Phonebook failed to read due to mobile phone disconnection, etc.
 - Check the mobile phone connection, and then conduct synchronising and adding again. (See page 75)
 - The connected mobile phone does not support synchronising of its phone book.
 - Connect the mobile phone that supports synchronising the phone book, then synchronise again. (See page 75)
-

HDMI

HDMI communication error,

Please check your device and operate it again.

- Communication error.
 - Turn the ignition key off, and then set to ON again.
 - Check the display by reconnecting between the HDMI and the unit, using the HDMI cable.
 - Check the display by reconnecting between the HDMI device and the unit.
-

HDMI current error,

Please Connect your device again.

- Abnormal current is run to the HDMI connector device.
 - Turn the ignition key off, and then set to ON again.
 - Disconnect the HDMI device from the unit, and then reconnect it.
-

HDMI monitor communication error.

Please check the connection or ACC off / on.

- HDMI device communication error.
 - Turn the engine (ACC) OFF/ON. Or, check the HDMI cable where it connects to the HDMI monitor.
-

Monitor connect via HDMI has been exceeded.

Please check the connection.

- More than 4 HDMI monitors are connected.
 - A cascade connection using more than 2 distributors is made.
 - Use one distributor and less than 4 HDMI monitors when connecting.
-

CAN Interface

CAN Communication Error

- Communication error.
 - Check the CAN Interface box connection.
-

Applying Alpine TuneIt App

You can not use Sound App

Because External AP is on.

- “Setting the External AP” (page 47) is “On.”
 - When “External AP” (page 47) is set to “On,” you cannot perform Sound Tuning from the Alpine TuneIt App. Set “External AP” to “Off” to perform Sound Tuning from the Alpine TuneIt App.

Navigation (X902D/X802D-U/INE-W710D only)

The vehicle's position is erroneous.

- The GPS reception is poor.
 - Drive the vehicle in an area of good GPS reception to allow the unit to recalibrate itself. Move to a location where strong GPS reception is possible.

No operation

- Moisture condensation
 - Allow enough time for the condensation to evaporate (about 1 hour).
- Ambient Temperature
 - Make sure the temperature inside the vehicle is between 0°C and 45°C (32°F and 113°F).

Specifications

MONITOR SECTION

Screen Size	9" (X902D/i902D) 8" (X802D-U) 7" (INE-W710D/iLX-702D)
LCD Type	Transparent type TN LCD
Operation System	TFT active matrix
Number of Picture Elements	1,152,000 pcs. (800 × 480 × 3 (RGB))
Effective Number of Picture Elements	99% or more
Illumination System	LED

FM TUNER SECTION

Tuning Range	87.5 – 108.0 MHz
Mono Usable Sensitivity	8.1 dBf (0.7 μV/75 ohms)
50 dB Quieting Sensitivity	12 dBf (1.1 μV/75 ohms)
Alternate Channel Selectivity	80 dB
Signal-to-Noise Ratio	65 dB
Stereo Separation	35 dB
Capture Ratio	2.0 dB

MW TUNER SECTION

Tuning Range	531 – 1,602 kHz
Usable Sensitivity	25.1 μV/28 dBf

LW TUNER SECTION

Tuning Range	153 – 281 kHz
Sensitivity (IEC Standard)	31.6 μV/30 dBf

DAB SECTION

Tuning Range BAND III	174.93 – 239.2 MHz
Tuning Range L-BAND	1,452.96 – 1,490.6 MHz
Usable Sensitivity	-103 dBm
Signal-to-Noise Ratio	95 dB
Stereo Separation	85 dB

USB SECTION

USB requirements	USB 2.0
Max. Power Consumption	1,500 mA (CDP Support)
USB Class	USB (Mass Storage Class)
File System	FAT16/32
Number of Channels	2-Channels (Stereo)
Frequency Response* ¹	5 – 20,000 Hz (±1 dB)
Total Harmonic Distortion	0.008% (at 1 kHz)
Dynamic Range	95 dB (at 1 kHz)
Signal-to-Noise Ratio	100 dB
Channel Separation	85 dB (at 1 kHz)

*¹ Frequency response may differ depending on the encoder software/bit rate.

HDMI SECTION

Input Format	480p/VGA
Output Format	480p

GPS SECTION

GPS Reception frequency	1,575.42 ±1 MHz
GPS Reception sensitivity	-130 dB max.

Bluetooth SECTION

Bluetooth Specification	Bluetooth v3.0
Frequency band	2,402 – 2,480 MHz
Output Power	+4 dBm Max. (Power class 2)
Profile	HFP (Hands-Free Profile) OPP (Object Push Profile) PBAP (Phone Book Access Profile) A2DP (Advanced Audio Distribution Profile) AVRCP (Audio/Video Remote Control Profile) SPP (Serial Port Profile)

GENERAL

Power Requirement	14.4 V DC (11–16 V allowable)
Operating temperature	-4°F to +140°F (-20°C to + 60°C)
Maximum Power Output	50 W × 4
Audio output level	
Preout (Front, Rear):	2V/10k ohms (max.)
Preout (Subwoofer):	2V/10k ohms (max.)
Weight	1.54 kg (3 lbs. 6 oz) (X802D-U) 1.41 kg (3 lbs. 2 oz) (INE-W710D/ iLX-702D)

CHASSIS SIZE

Width	198 mm (7-13/16") (X802D-U) 178 mm (7") (INE-W710D/ iLX-702D)
Height	125 mm (4-15/16") (X802D-U) 100 mm (3-15/16") (INE-W710D/ iLX-702D)
Depth	147 mm (5-3/4")

NOSE SIZE

Width	191 mm (7-1/2") (X802D-U) 171 mm (6-3/4") (INE-W710D/ iLX-702D)
Height	121 mm (4-3/4") (X802D-U) 96 mm (3-3/4") (INE-W710D/ iLX-702D)
Depth	19 mm (3/4")

- X902D/i902D is sized exclusively for a certain car model.
- Due to continuous product improvement, specifications and design are subject to change without notice.
- The LCD panel is manufactured using an extremely high precision manufacturing technology. Its effective pixel ratio is over 99.99%. This means that there is a possibility that 0.01% of the pixels could be either always ON or OFF.

About the Rules of Bluetooth Electromagnetic Radiation Regulation



Declaration of Conformity

AUTOMOTIVE PRODUCTS END USER LICENSE PROVISIONS (X902D/X802D-U/INE-W710D only)

The following terms and conditions apply to any use by you of any services provided by TomTom (the “**TomTom Services**”). The services are deemed to be provided by TomTom Global Content BV. You should not use the TomTom Services if you cannot agree to the below.

1. **GRANT OF LICENSE:** The TomTom Services are provided to you on a non-exclusive basis and you may only use the TomTom Services for your personal use and solely in combination with the hardware device which is incorporated into your vehicle. The license granted is non-transferable. If any software is provided as part of the TomTom services the you are only entitled to use the binary form of such software and have no right to receive the source code. If upgrades, updates or supplements to the TomTom Services are obtained or made available to you, the use of such upgrades, updates or supplements are subject to the foregoing unless other terms accompany such upgrades, updates or supplements in which case those terms apply. All other rights not specifically granted under this paragraph are reserved by TomTom.
2. **SAFETY:** The TomTom Services are intended to be used for providing information and navigation services related to your journey only and are not intended to be used as a safety related tool and cannot warn you about all dangers and hazards with respect to the road you are driving. Therefore, it remains your duty to drive in a careful and safe manner (paying all due care and attention to the road) as well as observing all applicable traffic regulations and rules. It is your responsibility not to use the TomTom Services in a manner that would distract you from driving safely.
3. **UPDATES AND CHANGES TO THE SERVICES AND THESE TERMS:** TomTom reserves the right, with or without notice, to discontinue, update, modify, upgrade and supplement the TomTom Services and to modify these terms.
4. **RESTRICTIONS:** You are prohibited from renting, lending, public presentation, performance or broadcasting or any other kind of distribution of the TomTom Services. Other than as permitted by applicable legislation, you will not, and you will not allow any person to, copy or modify the TomTom Services or any part thereof or to reverse engineer, decompile or disassemble the TomTom Services. You may not use the Services in connection with any illegal, fraudulent, dishonest or unethical activity or behaviour.
5. **OWNERSHIP:** All intellectual property rights related to the TomTom Services are owned by TomTom and/or its suppliers.

6. LIMITED WARRANTY:

- 6.1. YOU ACKNOWLEDGE THAT THE TOMTOM SERVICES HAVE NOT BEEN DEVELOPED TO MEET YOUR INDIVIDUAL REQUIREMENTS AND THAT IT IS THEREFORE YOUR RESPONSIBILITY TO ENSURE THAT THE FACILITIES AND FUNCTIONS OF THE TOMTOM SERVICES MEET YOUR REQUIREMENTS. TOMTOM DOES NOT AND CANNOT WARRANT THAT THE TOMTOM SERVICES OPERATE UNINTERRUPTED OR ERROR-FREE. YOU SHOULD BE PARTICULARLY AWARE OF THE FACT THAT CALCULATION ERRORS MAY OCCUR WHEN USING SOFTWARE IN A NAVIGATION SYSTEM WHICH MAY, FOR EXAMPLE, BE CAUSED BY LOCAL ENVIRONMENTAL CONDITIONS AND/OR INCOMPLETE DATA. TOMTOM DOES NOT WARRANT THAT THE TOMTOM SERVICES ARE CAPABLE OF INTEROPERATING WITH ANY OTHER SYSTEM, DEVICE OR PRODUCT (E.G. SOFTWARE OR HARDWARE).
- 6.2. WITHOUT LIMITING CLAUSE 6.1 ABOVE, THE TOMTOM SERVICES, AND ANY RESULTS GENERATED BY THE SERVICES ARE PROVIDED ON AN “AS IS” AND WITH ALL FAULTS BASIS” AND TOMTOM EXPRESSLY DISCLAIMS ALL OTHER WARRANTIES, EXPRESS OR IMPLIED, INCLUDING, BUT NOT LIMITED TO, THE IMPLIED WARRANTIES OF NON-INFRINGEMENT, MERCHANTABILITY, SATISFACTORY QUALITY, ACCURACY, TITLE AND FITNESS FOR A PARTICULAR PURPOSE.
- 6.3. THE PROVISIONS OF THIS CLAUSE DO NOT AFFECT ANY OF YOUR LEGAL RIGHTS UNDER APPLICABLE MANDATORY NATIONAL LEGISLATION, INCLUDING BUT NOT LIMITED TO ANY MANDATORY STATUTORY WARRANTIES. IF ANY PART OF THIS LIMITED WARRANTY IS HELD TO BE INVALID OR UNENFORCEABLE, THE REMAINDER OF THE LIMITED WARRANTY SHALL NONETHELESS REMAIN IN FULL FORCE AND EFFECT.

7. LIMITATION OF LIABILITY:

- 7.1. TO THE MAXIMUM EXTENT PERMITTED BY APPLICABLE LAW, NEITHER TOMTOM NOR ITS SUPPLIERS, OFFICERS, DIRECTORS OR EMPLOYEES SHALL BE LIABLE TO YOU OR TO ANY THIRD PARTY FOR ANY DAMAGES, WHETHER DIRECT, SPECIAL, INCIDENTAL, INDIRECT OR CONSEQUENTIAL (INCLUDING BUT NOT LIMITED TO, DAMAGES FOR THE INABILITY TO USE OR ACCESS THE SERVICES, LOSS OF DATA, LOSS OF BUSINESS, LOSS OF PROFITS, BUSINESS INTERRUPTION OR THE LIKE) ARISING OUT OF OR RELATED TO THE USE OF, THE INABILITY TO USE OR ACCESS, OR OTHERWISE THE PERFORMANCE OF THE SERVICES, EVEN IF TOMTOM HAS BEEN ADVISED OF THE POSSIBILITY OF SUCH DAMAGES.
- 7.2. TO THE EXTENT TOMTOM IS NOT PERMITTED UNDER APPLICABLE LAW TO EXCLUDE ITS LIABILITY PURSUANT TO CLAUSE 7.1 ABOVE, TOMTOM’S TOTAL AGGREGATE LIABILITY TO YOU SHALL BE LIMITED TO THE AMOUNT OF US \$100.00.
- 7.3. THE ABOVE LIMITATIONS OF LIABILITY UNDER THIS CLAUSE 7 DO NOT: (I) AFFECT YOUR RIGHTS UNDER ANY APPLICABLE MANDATORY NATIONAL LEGISLATION; (II) EXCLUDE OR LIMIT ANY LIABILITY THAT CANNOT BE EXCLUDED OR LIMITED UNDER APPLICABLE LAW.

8. **LINKS TO THIRD PARTY SITES:** TomTom is not responsible for the contents of any third-party sites or services, any links contained in third-party sites or services, or any changes or updates to third-party sites or services which are delivered by the TomTom Services or otherwise. TomTom is providing these links and access to third-party sites and services to you only as a convenience, and the inclusion of any link or access does not imply an endorsement by TomTom or any Third Parties of the third-party site or service. Any use by you of such links or third party sites and the manner in which you use such third party sites and links shall be your responsibility and at your risk and you shall not use them in any illegal or fraudulent manner.
9. **TERMINATION AND DIRECT ENFORCEMENT:** Without prejudice to any other rights, TomTom may immediately terminate this EULA if you fail to comply with any of its terms and conditions. The provisions of this Agreement, which by their nature are intended to survive termination, will remain in effect after termination of this EULA. Furthermore, you agree that TomTom may directly enforce these terms against you.

DEVICES THAT EMIT RADIO WAVES. The following products and systems on your vehicle emit radio waves when in operation.

SIMPLIFIED EU DECLARATION OF CONFORMITY

Hereby, ALPINE ELECTRONICS, INC. declares that the radio equipment type X902D, X802D-U, INE-W710D, i902D, iLX-702D is in compliance with Directive 2014/53/EU. The full text of the EU declaration of conformity is available at the following internet address:

<http://www.alpine.com/e/research/doc/>

Compliant with UNECE Regulation 10 (E-Mark)



[EN] English	Hereby, Alpine Electronics, inc. declares that the radio equipment type X902D, X802D-U, INE-W710D, i902D, iLX-702D is in compliance with Directive 2014/53/EU. The full text of the EU declaration of conformity is available at the following internet address: http://www.alpine.com/e/research/doc/
[BG] Bulgarian	С настоящото Alpine Electronics, inc. декларира, че този тип радиос ъоръжение X902D, X802D-U, INE-W710D, i902D, iLX-702D е в съответствие с Директива 2014/53/ЕС. Цялостният текст на ЕС декларацията за съответствие може да се намери на следния интернет адрес: http://www.alpine.com/e/research/doc/
[CZ] Czech	Tímto Alpine Electronics, inc. prohlašuje, že typ rádiového zařízení X902D, X802D-U, INE-W710D, i902D, iLX-702D je v souladu se směrnicí 2014/53/EU. Úplné znění EU prohlášení o shodě je k dispozici na této internetové adrese: http://www.alpine.com/e/research/doc/
[DA] Danish	Hermed erklærer Alpine Electronics, inc., at radioudstyretypen X902D, X802D-U, INE-W710D, i902D, iLX-702D er i overensstemmelse med direktiv 2014/53/EU. EU-overensstemmelseserklæringens fulde tekst kan findes på følgende internetadresse: http://www.alpine.com/e/research/doc/
[DE] German	Hiermit erkläre Alpine Electronics, inc., dass der Funkanlagentyp X902D, X802D-U, INE-W710D, i902D, iLX-702D der Richtlinie 2014/53/EU entspricht. Der vollständige Text der EU-Konformitätserklärung ist unter der folgenden Internetadresse verfügbar: http://www.alpine.com/e/research/doc/
[EL] Greek	Με την παρούσα ο/η Alpine Electronics, inc., δηλώνει ότι ο ραδιοεξοπλισμός X902D, X802D-U, INE-W710D, i902D, iLX-702D πληροί την οδηγία 2014/53/ΕΕ. Το πλήρες κείμενο της δήλωσης συμμόρφωσης ΕΕ διατίθεται στην ακόλουθη ιστ σελίδα στο διαδίκτυο: http://www.alpine.com/e/research/doc/
[ES] Spanish	Por la presente, Alpine Electronics, inc. declara que el tipo de equiporadioeléctrico X902D, X802D-U, INE-W710D, i902D, iLX-702D es conforme con la Directiva 2014/53/UE. El texto completo de la declaración UE de conformidad está disponible en la dirección Internet siguiente: http://www.alpine.com/e/research/doc/
[ET] Estonian	Käesolevaga deklareerib Alpine Electronics, inc. et käesolev raadioseadme tüüp X902D, X802D-U, INE-W710D, i902D, iLX-702D vastab direktiivi 2014/53/EL nõuetele. Eli vastavusdeklaratsiooni täielik tekst on kättesaadav järgmisel internetiaadressil: http://www.alpine.com/e/research/doc/
[FI] Finnish	Alpine Electronics, inc. vakuuttaa, että radiolaitetyypit X902D, X802D-U, INE-W710D, i902D, iLX-702D on direktiivin 2014/53/EU mukainen. EU-vaatimustenmukaisuusvakuutuksen täysimittainen teksti on saatavilla seuraavassa internetosoitteessa: http://www.alpine.com/e/research/doc/
[FR] French	Le soussigné, Alpine Electronics, inc., déclare que l'équipement radioé lectrique du type X902D, X802D-U, INE-W710D, i902D, iLX-702D est conforme à la directive 2014/53/UE. Le texte complet de la déclaration UE de conformité est disponible à l'adresse internet suivante: http://www.alpine.com/e/research/doc/
[HR] Croatian	Alpine Electronics, inc. ovime izjavljuje da je radijska oprema tipa X902D, X802D-U, INE-W710D, i902D, iLX-702D u skladu s Direktivom 2014/53/EU. Cjeloviti tekst EU izjave o sukladnosti dostupan je na sljedećoj internetskoj adresi: http://www.alpine.com/e/research/doc/
[HU] Hungarian	Alpine Electronics, inc. igazolja, hogy a X902D, X802D-U, INE-W710D, i902D, iLX-702D típusú rádióberendezé s megfelel a 2014/53/EU irányelvnek. Az EU-megfelelőségi nyilatkozat teljes szövege elérhető a következő internetes címen: http://www.alpine.com/e/research/doc/
[IS] Icelandic	Hér, Alpine Electronics, inc. lýsir yfir að radióbúnaður tegund X902D, X802D-U, INE-W710D, i902D, iLX-702D er í samræmi við tilskipun 2014/53/ESB. The fullur texti af ESB-samræmisýfirlýsing er í boði á eftirfarandi veffangi: http://www.alpine.com/e/research/doc/
[IT] Italian	Il fabbricante, Alpine Electronics, inc., dichiara che il tipo di apparecchiatura radio X902D, X802D-U, INE-W710D, i902D, iLX-702D è conforme alla direttiva 2014/53/UE. Il testo completo della dichiarazione di conformità UE è disponibile al seguente indirizzo Internet: http://www.alpine.com/e/research/doc/
[LT] Lithuanian	Aš, Alpine Electronics, inc., patvirtinu, kad radijo įrenginių tipas X902D, X802D-U, INE-W710D, i902D, iLX-702D atitinka Direktyvą 2014/53/ES. Visas ES atitikties deklaracijos tekstas prieinamas šiuo interneto adresu: http://www.alpine.com/e/research/doc/

[LV] Latvian	Ar šo Alpine Electronics, inc. deklarē, ka radioiekārta X902D, X802D-U, INE-W710D, i902D, iLX-702D atbilst Direktīvai 2014/53/ES. Pilns ES atbilstības deklarācijas teksts ir pieejams šādā interneta vietnē: http://www.alpine.com/e/research/doc/
[MT] Maltese	B'dan, Alpine Electronics, inc., niddikjara li dan it-tip ta' tagħmir tar-radju X902D, X802D-U, INE-W710D, i902D, iLX-702D huwa konformi maċ-Direttiva 2014/53/UE. It-test kollu tad-dikjarazzjoni ta' konformità tal-UE huwa disponibbli f'dan l-indirizz tal-Internet li ġej: http://www.alpine.com/e/research/doc/
[NL] Dutch	Hierbij verklaar ik, Alpine Electronics, inc., dat het type radioapparatuur X902D, X802D-U, INE-W710D, i902D, iLX-702D conform is met Richtlijn 2014/53/EU. De volledige tekst van de EU-conformiteitsverklaring kan worden geraadpleegd op het volgende internetadres: http://www.alpine.com/e/research/doc/
[NO] Norwegian	Herved Alpine Electronics, inc. erklærer at radioutstyr type X902D, X802D-U, INE-W710D, i902D, iLX-702D er i samsvar med direktiv 2014/53/EU. Den fullstendige teksten i EU-erklæring er tilgjengelig på følgende internetadresse: http://www.alpine.com/e/research/doc/
[PL] Polish	Alpine Electronics, inc. niniejszym oświadcza, że typ urządzenia radiowego X902D, X802D-U, INE-W710D, i902D, iLX-702D jest zgodny z dyrektywą 2014/53/UE. Pełny tekst deklaracji zgodności UE jest dostępny pod następującym adresem internetowym: http://www.alpine.com/e/research/doc/
[PT] Portuguese	O(a) abaixo assinado(a) Alpine Electronics, inc. declara que o presente tipo de equipamento de rádio X902D, X802D-U, INE-W710D, i902D, iLX-702D está em conformidade com a Diretiva 2014/53/UE. O texto integral da declaração de conformidade está disponível no seguinte endereço de Internet: http://www.alpine.com/e/research/doc/
[RO] Romanian	Prin prezenta, Alpine Electronics, inc. declară că tipul de echipamente radio X902D, X802D-U, INE-W710D, i902D, iLX-702D este în conformitate cu Directiva 2014/53/UE. Textul integral al declarației UE de conformitate este disponibil la următoarea adresă internet: http://www.alpine.com/e/research/doc/
[SK] Slovak	Alpine Electronics, inc. týmto vyhlasuje, že rádiové zariadenie typu X902D, X802D-U, INE-W710D, i902D, iLX-702D je v súlade so smernicou 2014/53/EÚ. Úplné EÚ vyhlásenie o zhode je k dispozícii na tejto internetovej adrese: http://www.alpine.com/e/research/doc/
[SL] Slovenian	Alpine Electronics, inc. potrjuje, da je tip radijske opreme X902D, X802D-U, INE-W710D, i902D, iLX-702D skladen z Direktivo 2014/53/EU. Celotno besedilo izjave EU o skladnosti je na voljo na naslednjem spletnem naslovu: http://www.alpine.com/e/research/doc/
[SV] Swedish	Härmed försäkrar Alpine Electronics, inc. att denna typ av radioutrustning X902D, X802D-U, INE-W710D, i902D, iLX-702D överensstämmer med direktiv 2014/53/EU. Den fullständiga texten till EU-försäkran om överensstämmelse finns på följande webbadress: http://www.alpine.com/e/research/doc/
[TR] Turkey	İşbu beyanla, Alpine Electronics, inc. radyo ekipmanı tipinin X902D, X802D-U, INE-W710D, i902D, iLX-702D, Directive 2014/53/ EU yönergesine uyduğunu ilan eder. EU uyumluluk ilanının tam metnine (Declaration of Conformity) aşağıdaki internet adresinden ulaşılabilir. http://www.alpine.com/e/research/doc/



Information on Disposal of Old Electrical and Electronic Equipment and Battery (applicable for countries that have adopted separate waste collection systems)

If you want to dispose this product, do not mix it with general household waste. There is a separate collection system for used electronic products in accordance with legislation that requires proper treatment, recovery and recycling. Contact your local authority for details in locating a recycle facility nearest to you. Proper recycling and waste disposal will help conserve resources whilst preventing detrimental effects on our health and the environment.