

OWNER'S MANUAL

XD300/1v2

300W Monoblock Subwoofer Amplifier



NexD™
SWITCHING TECHNOLOGY

*Thank you for purchasing a JL Audio amplifier for
your automotive sound system.*

*Your amplifier has been designed and manufactured to exacting
standards in order to ensure years of musical enjoyment in your vehicle.*

*For maximum performance, we highly recommend that you have
your new amplifier installed by an authorized JL Audio dealer. Your
authorized dealer has the training, expertise and installation equipment
to ensure optimum performance from this product. Should you
decide to install the amplifier yourself, please take the time
to read this manual thoroughly to familiarize yourself
with its installation requirements and setup procedures.*

*If you have any questions regarding the instructions in this
manual or any aspect of your amplifier's operation, please contact your
authorized JL Audio dealer for assistance. If you need further assistance,
please call the JL Audio Technical Support Department
at (954) 443-1100 during business hours.*



PROTECT YOUR HEARING!

We value you as a long-term customer. For that reason, we urge you to practice restraint in the operation of this product so as not to damage your hearing and that of others in your vehicle. Studies have shown that continuous exposure to high sound pressure levels can lead to permanent (irreparable) hearing loss. This and all other high-power amplifiers are capable of producing such high sound pressure levels when connected to a speaker system. Please limit your continuous exposure to high volume levels.

While driving, operate your audio system in a manner that still allows you to hear necessary noises to operate your vehicle safely (horns, sirens, etc.).

SERIAL NUMBER

In the event that your amplifier requires service or is ever stolen, you will need to have a record of the product's serial number. Please take the time to enter that number in the space provided below. The serial number can be found on the bottom panel of the amplifier and on the amplifier packaging.

Serial Number:

INSTALLATION APPLICATIONS

This amplifier is designed for operation in vehicles with 12 volt, negative-ground electrical systems. Use of this product in vehicles with positive ground and/or voltages other than 12V may result in damage to the product and will void the warranty.

This product is not certified or approved for use in aircraft.

Do not attempt to "bridge" the outputs of this amplifier with the outputs of a second amplifier, including an identical one.

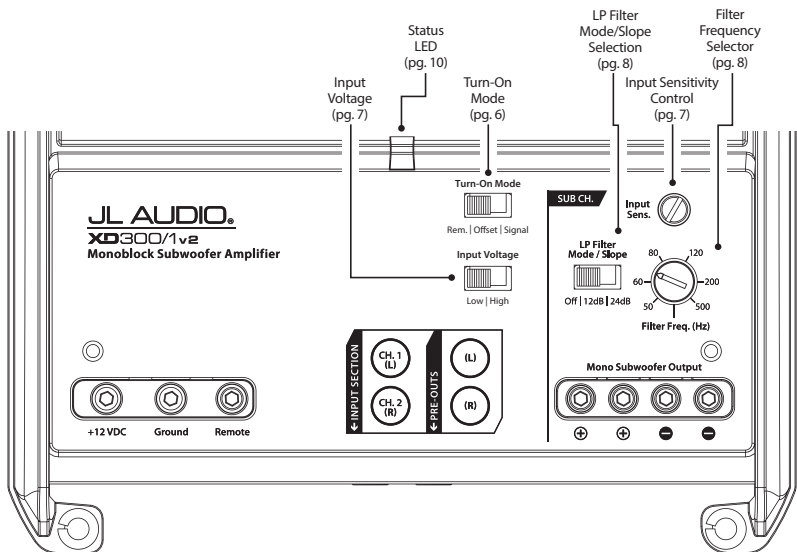

PLANNING YOUR INSTALLATION

It is important that you take the time to read this manual and that you plan out your installation carefully. The following are some considerations that you must take into account when planning your installation.

Cooling Efficiency Considerations:

The outer shell of your JL Audio amplifier is designed to remove heat from the amplifier circuitry. For optimum cooling performance, this outer shell should be exposed to the largest possible volume of air. Enclosing the amplifier in a small, poorly ventilated chamber can lead to excessive heat build-up and degraded performance. If an installation calls for an enclosure around the amplifier, we recommend that this enclosure be ventilated with the aid of a fan. In normal applications, fan-cooling is not necessary.

! IMPORTANT

Mounting the amplifier upside down is strongly discouraged. If mounting the amplifier under a seat, make sure there is at least 1 inch (2.5 cm) of space above the amplifier's outer shell to permit proper cooling.

Safety Considerations:

Your amplifier needs to be installed in a dry, well-ventilated environment and in a manner which does not interfere with your vehicle's safety equipment (air bags, seat belt systems, ABS brake systems, etc.). You should also take the time to securely mount the amplifier so that it does not come loose in the event of a collision or a sudden jolt to the vehicle.

Stupid Mistakes to Avoid

- Check before drilling any holes in your vehicle to make sure that you will not be drilling through a gas tank, brake line, wiring harness or other vital vehicle system.
- Do not run system wiring outside or underneath the vehicle. This is an extremely dangerous practice which can result in severe damage to your vehicle and person.
- Protect all system wires from sharp metal edges and wear by carefully routing them, tying them down and using grommets and loom where appropriate.
- Do not mount the amplifier in the engine compartment, under the vehicle, on the roof or in any other area that will expose the amplifier circuitry to the elements.

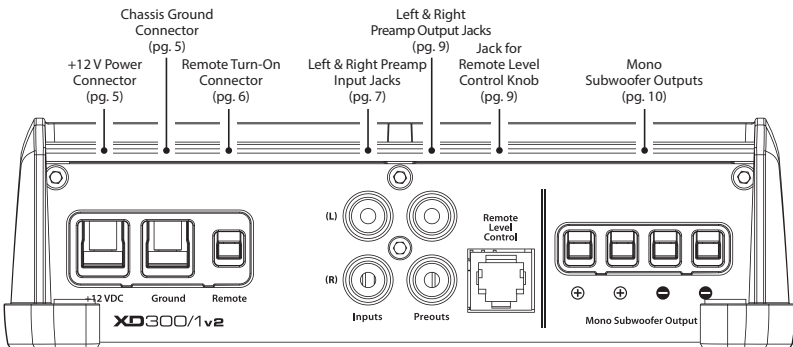

PRODUCT DESCRIPTION

The XD300/1v2 is a monoblock amplifier utilizing JL Audio NexD™ high speed switching technology to deliver outstanding fidelity and efficiency.

The XD300/1v2 can be operated with a wide variety of source units and system configurations.

Its frequency response is limited to the range below 500 Hz. It is not designed for driving midrange speakers or tweeters. Every aspect of its operation has been optimized for low-frequency amplification. For detailed specifications, please refer to Appendix C (page 13).

TYPICAL INSTALLATION SEQUENCE

The following represents the sequence for a typical amplifier installation, using an aftermarket source unit or OEM Interface processor (like the CleanSweep CL441dsp). Additional steps and different procedures may be required in some applications. If you have any questions, please contact your authorized JL Audio dealer for assistance.

- 1) Disconnect the negative battery post connection and secure the disconnected cable to prevent accidental reconnection during installation. **This step is not optional.**
- 2) Run 8 or 4 AWG power wire from the battery location to the amplifier mounting location, taking care to route it in such a way that it will not be damaged and will not interfere with vehicle operation. Use 4 AWG or larger power wire and a fused power distribution block if additional amplifiers are being installed with the XD300/1v2.
- 3) Connect the power wire to the positive battery post. Fuse the wire with an appropriate fuse block (and connectors) within 18 inches (45 cm) wire length of the positive battery post. **This fuse is essential to protect the vehicle. Do not install the fuse until the power wire has been securely connected to the amplifier.**
- 4) Run signal cables and remote turn-on wire from the source unit to the final amplifier mounting location.
- 5) Run speaker cables from the speaker systems to the amplifier mounting location.
- 6) Find a good, solid metal grounding point close to the amplifier and connect the negative power wire to it using appropriate hardware (use of the JL Audio ECS master ground lug, XB-MGLU is recommended). Use 8 or 4 AWG wire, no longer than 36 inches (90 cm) from the amplifier to the ground connection point. In some vehicles, it may be necessary to upgrade the battery ground wire. (See page 5 for important notice).
- 7) Securely mount the amplifier.
- 8) Connect the positive and negative power wires to the amplifier. A fuse near the amplifier is not necessary if the XD300/1v2 is the only device being run from the fused main power wire. If the fused main power wire is shared by the XD300/1v2 and other amplifiers or devices, fuse each amplifier/device within 12 inches (30 cm) of wire length, via a fused distribution block or multiple individual fuse blocks/on-board fuses.
- 9) Connect the remote turn-on wire to the amplifier or configure the “**Turn-On Mode**” switch for automatic turn-on.
- 10) Connect the input cables to the amplifier.
- 11) Connect the speaker cables to the amplifier.
- 12) Carefully review the amplifier’s control settings to make sure that they are set according to the needs of the system.
- 13) Install the power wire fuse (30A for a single XD300/1v2) and reconnect the negative battery post terminal. Install the fuse (30A) near the amplifier (if applicable).
- 14) Turn on the source unit at a low level to double-check that the amplifier is configured correctly. Resist the temptation to crank it up until you have verified the control settings.
- 15) Make necessary adjustments to the input sensitivity controls to obtain the right overall output and the desired balance in the system. See Appendix A (page 12) for the recommended input sensitivity setting method.
- 16) Enjoy the fruits of your labor with your favorite music.

POWER CONNECTIONS

Before installing the amplifier, disconnect the negative (ground) wire from the vehicle's battery. This will prevent accidental damage to the system, the vehicle and your body during installation.

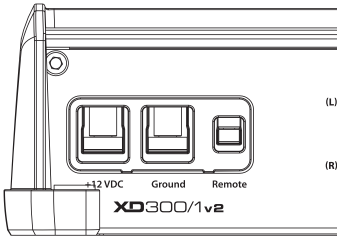

The XD300/1v2's "+12 VDC" and "Ground" connections are designed to accept 4 AWG power wire. **8 AWG is the minimum wire size for this amplifier.**

If you are installing the XD300/1v2 with other amplifiers and wish to use a single main power wire, use 4 AWG, 2 AWG or 1/0 AWG main power wire (depending on the overall current demands of all the amplifiers in the system). This large power wire should terminate into a fused distribution block mounted as close to the amplifiers as possible (within 12 inches / 30cm of wire length). The fused output of the distribution block will connect to the XD300/1v2 with 8 or 4 AWG power wire. JL Audio ECS fused distribution blocks are recommended (XD-FDBU-2 and XD-FDBU-4).

Note: Smaller AWG numbers mean bigger wire and vice-versa (1/0 AWG is the largest, 2 AWG is smaller, then 4 AWG, then 8 AWG, etc.).

To connect the power wires to the amplifier, first back out the set screw on the top of the terminal block, using the supplied 2.5 mm hex wrench. Strip 1/2 inch (12 mm) of insulation from the end of each wire and insert the bare wire into the terminal block, seating it firmly so that no bare wire is exposed. While holding the wire in place, tighten the set screw firmly, taking care not to strip the head of the screw.

The ground connection should be made using 8 or 4 AWG wire and should be kept as short as possible, while accessing a solid piece of sheet metal in the vehicle. The surface of the sheet metal should be sanded at the contact point to create a clean, metal-to-metal connection between the chassis and the termination of the ground wire. For optimal grounding, we recommend the use of a JL Audio ECS master ground lug (XB-MGLU). Alternatively, a sheet metal screw or bolt can be used with a star washer.

Any wires run through metal barriers (such as firewalls), must be protected with a high quality rubber grommet to prevent damage to the insulation of the wire. Failure to do so may result in a dangerous short circuit.

! IMPORTANT

Many vehicles employ small (10 AWG - 6 AWG) wire to ground the battery to the vehicle chassis and to connect the alternator's positive connection to the battery. To prevent voltage drops, these wires should be upgraded to 4 AWG when installing amplifier systems with main fuse ratings above 60A.

FUSE REQUIREMENTS

It is absolutely vital that the main power wire(s) to the amplifier(s) in the system be fused within 18 inches (45 cm) of the positive battery post connection. The fuse value at each power wire should be high enough for all of the equipment being run from that power wire. If only the XD300/1v2 is being run from that power wire, use a 30A fuse.

If fusing the amplifier near its power connections (when more than one amp is being run from the main power wire), use a 30A fuse (MAXI™ big plastic-body fuse is recommended).

TURN-ON OPTIONS

The XD300/1v2 can be switched on and off using one of three methods, determined by the position of the amplifier's "Turn-On Mode" switch. Please read these options and decide which is best suited for your specific system.

- 1) +12V remote turn-on lead
- 2) Signal-sensing turn-on circuit.
- 3) DC offset-sensing turn-on circuit

+12 V Remote Turn-On: This is the preferred method for turning the amplifier on/off. The amplifier will turn on when +12 V is present at its "Remote" input and turn off when +12 V is switched off. This +12 V remote turn-on signal is typically controlled by a source unit's remote turn-on wire. The XD300/1v2's "Remote" turn-on connector will accept 18 AWG – 12 AWG wire. To connect the remote turn-on wire to the amplifier, first back out the set screw on the top of the terminal block, using the supplied 2.5 mm hex wrench. Strip 1/2 inch (12mm) of wire and insert the bare wire into the terminal block, seating it firmly so that no bare wire is exposed. While holding the wire in the terminal, tighten the set screw firmly, taking care not to strip the head of the screw and making sure that the wire is firmly gripped by the set screw.

If a source unit does not have a dedicated remote turn-on output, consider one of the following alternative turn-on options:

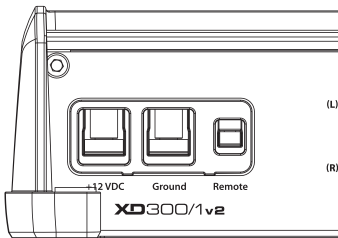

These methods are useful when a conventional +12 V remote turn-on signal is not available in a system. These allow you to operate the amplifier without having to locate a remote turn-on lead at the source unit, which can be very useful when interfacing the amplifier with OEM (factory)

audio systems that do not use conventional +12 V turn-on leads.

Depending on the characteristics of the audio signal, one of the following methods may work better than the other. We recommend trying DC Offset-Sensing first as it does not require a long delay to turn the system off after the signal is shut off.

DC Offset-Sensing: The amplifier will turn on and off by detecting the presence of a very small DC signal (offset) that is typical in the audio output of most OEM (factory) source units and amplifiers. The amplifier will turn on and off in reaction to the presence or absence of this DC Offset. The sensitivity of this circuit is designed for high-level (speaker level) signals, not for low-level (preamp level) signals. **The circuit senses the left-channel signal only.**

Signal-Sensing: The amplifier will turn on and off by detecting the presence of a full-range audio signal at its left-channel input. After approximately 30 seconds, the amplifier will shut off. The sensitivity of this circuit is designed for high-level (speaker level) signals, not for low-level (preamp level) signals. The circuit is tuned to react to signals at mid-range frequencies. This prevents false switching from signals created by moving loudspeakers that are in parallel with the amplifier's input signal.

In signal sensing and DC offset sensing applications, the amplifier's "Remote" turn-on terminal becomes a remote turn-on output. This allows the XD300/1v2 to turn on other amplifiers in the audio system that do not have signal sensing or DC offset sensing. Of course, the XD300/1v2 must be the first amplifier in the signal path for this to function properly.

INPUT SECTION

The XD300/1v2 employs a differential-balanced input topology that provides the user with a high degree of input flexibility, while retaining superior noise rejection. This type of circuit also allows the XD300/1v2 to accept high-voltage inputs from factory source unit outputs without excessive distortion or noise problems.

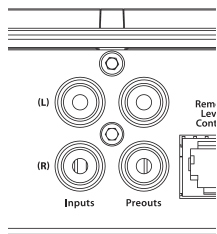

You may run a stereo or a mono signal into the inputs of the amplifier. The amplifier's input section automatically sums stereo signals to mono for the internal amplifier section. The amplifier will operate with only one input connection but will require an increase in input sensitivity to overcome the loss of signal. If a mono input signal is to be run, we recommend that you use a "Y-adaptor" to split the mono signal into both inputs of the amplifier. If you are feeding only one input and using either the DC-Offset or Signal Sensing "Turn-On Mode", you must use the left-channel input for the automatic turn-on to operate.

Input Voltage Range:

A wide range of signal input voltages can be accommodated by the XD300/1v2's input section (200mV – 8V). This wide range is split up into two sub-ranges, accessible via the "Input Voltage" switch:

"Low": for preamp level signals

"High": for speaker level signals

The "Low" position on the "Input Voltage" switch selects an input sensitivity range between 200mV and 2V. This means that the "Input Sens." rotary control will operate within that voltage window. If you are using an aftermarket source unit, with conventional preamp level outputs, this is the position you should select.

The "High" position on the "Input Voltage" switch selects an input sensitivity range between 800mV and 8V. This is useful for certain high-output preamp level signals as well as speaker level output from source units and small amplifiers. To use speaker level sources, splice the speaker output wires of the source unit or small

amplifier onto a pair of RCA cables or plugs, or use the JL Audio ECS Speaker Wire to RCA adaptor (XD-CLRAIC2-SW).

Line output converters are usually not needed with the XD300/1v2. If you find that the output cannot be reduced sufficiently with a direct speaker level signal applied to the amplifier and the "Input Voltage" switch in its "High" position, you may use a line output converter or voltage divider to reduce the signal level.

INPUT SENSITIVITY CONTROLS

The control labeled "Input Sens." can be used to match the source unit's output voltage to the input stage of the XD300/1v2 for maximum clean output. Rotating the control clockwise will result in higher sensitivity (louder for a given input voltage). Rotating the control counter-clockwise will result in lower sensitivity (quieter for a given input voltage).

To properly set the amplifier for maximum clean output, please refer to Appendix A (page 12) in this manual. After using this procedure, you can then adjust the "Input Sens." levels downward if this is required to achieve the desired system

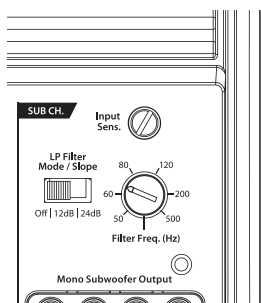

Do not increase any "Input Sens." setting for any channel(s) of any amplifier in the system beyond the maximum level established during the procedure outlined in Appendix A (page 12). Doing so will result in audible distortion and possible speaker damage.

FILTER CONTROLS

Most speakers are not designed to reproduce the full range of frequencies audible by the human ear. For this reason, most speaker systems are comprised of multiple speakers, each dedicated to reproducing a specific frequency range. Filters are used to select which frequency range is sent to each section of a speaker system. The division of frequency ranges to different speakers can be done with passive filters (coils and/or capacitors between the amplifier outputs and the speakers), which are acceptable and commonly used for filtering between mid-range speakers and tweeters. Filtering between subwoofer systems and satellite speaker systems is best done with active filters, which cut off frequency content at the input to the amplifier. Active filters are more stable than passive filters and do not introduce extraneous resistance, which can degrade subwoofer performance.

The active low-pass filter built into the XD300/1v2 is designed to attenuate frequencies above its filter frequency, so that the system's subwoofers do not reproduce any audible midrange content.

This serves to improve tonal balance and to avoid distortion. Correct use of the filter can substantially improve the fidelity of your audio system.

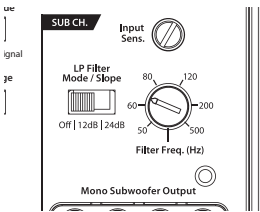

2) LP Filter Operation: The low-pass filter in the XD300/1v2 is fully variable between 50 Hz and 500 Hz via the “**Filter Freq.**” control knob and features the ability to select between a moderate “**12dB**” per octave or a steep “**24dB**” per octave slope via the “**LP Filter Mode/Slope**” switch. Depending on the subwoofer system and the vehicle, different slopes may be required to produce a smooth transition to the mid-bass speakers in the system. Experiment to find the slope which best matches the acoustic requirements of your system.

Tuning Hint: A trunk mounted sub whose output has to “fight” through a rear deck or a back seat often benefits from the 12 dB/octave slope which lets more upper bass content pass through. A sub that fires directly into the listening environment is more likely to benefit from a 24 dB/octave slope.

Note: The above hint is not “set-in-stone”... You should always listen to the system carefully to determine the best choice as vehicle acoustics and other factors play a big role in choosing the most appropriate filter slope.

3) Precise Frequency Selection: The filter frequency markings on the front panel of the amplifier are for reference purposes and are generally accurate to within 1/3 octave or better. If you would like to select the filter frequency with a higher level of precision, consult Appendix B (page 13) of this manual. This chart gives you a more accurate frequency for each of the forty detented positions of the frequency selection control. This method can be very useful if the amplifier is mounted in a location where you can't see the front panel markings easily.

4) Defeating the LP Filter: The Low-Pass filter can also be defeated completely, by switching the “**LP Filter Mode/Slope**” switch to the “**Off**” position. This is useful if you are using an external active crossover in the system. With the internal crossover turned off, the XD300/1v2's upper frequency response limit is 500 Hz, due to its subwoofer-specific design.

REMOTE LEVEL CONTROL (OPTIONAL)

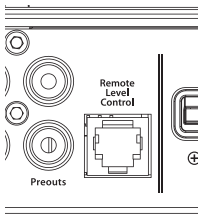

With the addition of the optional Remote Level Control (HD-RLC), you can control the subwoofer volume from the front of the vehicle.

The HD-RLC connects to the jack labeled “**Remote Level Control**” on the Connection Panel of the amplifier using a standard telephone cable (supplied with the HD-RLC). If desired, multiple XD (and HD) amplifiers can be controlled from a single HD-RLC controller using a single-line, four-wire phone line splitter and multiple phone cables.

When connected to the amplifier, the HD-RLC operates as follows: At full counter-clockwise rotation, the audio will mute completely. At full clockwise rotation the level will be the same as if the HD-RLC was not connected at all. In other words, it operates strictly as a level **attenuator**.

PREOUTS

The XD300/1v2 incorporates a buffered, pass-through preamp output section, so that additional amplifiers can be easily added to the system. The preamp output delivers the same signal that is connected to the XD300/1v2’s inputs.

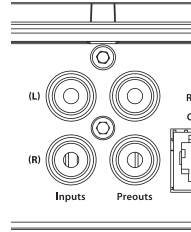

The preamp output signal is not affected by the amplifier’s LP Filter (if the input signal is full-range, the preamp output will be full-range).

Note: When the “**Input Voltage**” switch is in its “**Low**” position, the level of the “**Preouts**” signals matches the input signal levels (unity gain). When the “**Input Level**” switch is in the “high” position, the level of the input signal is attenuated -12 dB to produce a line level signal at the “**Preouts**”. This ensures a proper line level signal output under both conditions.

! IMPORTANT

If you plan to use the “**Preouts**” to feed a stereo amplifier, you must connect a stereo signal to the input of the amplifier. A mono signal into the amplifier will result in a mono signal out of the preamp output.

SUBWOOFER OUTPUTS

The XD300/1v2 is designed to deliver power into subwoofer loads equal to or greater than 2 ohms of nominal impedance.

The XD300/1v2's subwoofer outputs are designed to accept 16 AWG - 8 AWG wire. To connect the subwoofer wires to the amplifier, first back out the set screws on the top of the terminal block, using the supplied 2.5 mm hex wrench. Strip 1/2 inch (12 mm) of insulation from the end of each wire and insert the bare wire into the terminal block, seating it firmly so that no bare wire is exposed. While holding the wire in place, tighten the set screw firmly, taking care not to strip the head of the screw.

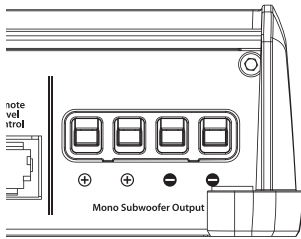

You will notice that there are two “+” positive connections and two “-” negative connections. This is to facilitate multiple subwoofer wiring. The two positive and two negative connections are connected in parallel inside the amplifier. They are not stereo outputs. **Connecting two subwoofers, each to one set of positive and negative terminals, will result in a parallel subwoofer connection. When only connecting one pair of subwoofer wires, it is not necessary to use both sets of connections.**

! IMPORTANT

Subwoofer loads below 2 ohms nominal are not recommended and may cause the amplifier to initiate a protection mode which reduces power output.

STATUS LED / PROTECTION CIRCUITRY

There is a single multi-color LED on the top surface of the amplifier to indicate the amplifier's operating status.

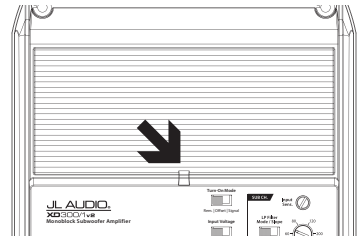

- 1) Flashing Green:** The amplifier is powering up, audio output is muted.
- 2) Constant Green:** The amplifier is on and functioning normally, audio output is active.
- 3) Constant Red:** lights to indicate that the amplifier has exceeded its safe operating temperature, putting the amplifier into a self-protection mode, which reduces the peak power output of the amplifier. When its temperature returns to a safe level, the red light will return to green and the amplifier will return to full-power operating mode.
- 4) Constant Amber (Yellow):** Indicates that an over-current condition has occurred and is accompanied by a muting of the amplifier's output. Because the muting behavior may be very short in duration, it may manifest itself as an audible, repetitive ticking or thumping noise in the output. Over-current conditions can be caused by a speaker impedance lower than the optimum load impedance range for the amplifier or a short-circuit in the speaker wiring. The latter can result from a short circuit between the positive and negative speaker wires or between either speaker wire and the vehicle chassis. The “**Status LED**” will remain amber for a few seconds, even if the over-current condition is of a very short duration.

5) LED off / Amplifier Shuts Off Unexpectedly

The only condition that will shut down an undamaged XD300/1v2 completely is if battery voltage or remote turn-on voltage drops below 10 volts. The “**Status LED**” will turn off when this occurs. The amplifier will turn back on when voltage climbs back above 11 volts. If this is happening in your system, have your charging system and power wiring inspected.

For more information on troubleshooting this amplifier, refer to Appendix D (pages 14, 15).

SERVICING YOUR JL AUDIO AMPLIFIER

If your amplifier fails or malfunctions, please return it to your authorized JL Audio dealer so that it may be sent in to JL Audio for service. There are no user serviceable parts or fuses inside the amplifier. The unique nature of the circuitry in the JL Audio amplifiers requires specifically trained service personnel. Do not attempt to service the amplifier yourself or through unauthorized repair facilities. This will not only void the warranty, but may result in the creation of more problems within the amplifier.

If you have any questions about the installation or setup of the amplifier that have not been covered in this manual, please contact your dealer or technical support.

JL Audio Technical Support:

(954) 443-1100

9:00 AM – 5:30 PM (Eastern Time Zone)

Monday - Friday

APPENDIX A:

Input Sensitivity Level Setting

Following the directions below will allow the installer to adjust the input sensitivity of each amplifier channel pair simply and easily in just a few minutes using equipment which is commonly available in installation bays.

Necessary Equipment

- Digital AC Voltmeter
- CD with a sine-wave test tone recorded at 0 dB reference level in the frequency range to be amplified for that set of channels (50 Hz for subwoofer channels, 1 kHz for a midrange application). Do not use attenuated test tones (-10 dB, -20 dB, etc.).

The Nine-Step Procedure

- 1) Disconnect the speaker(s) from the amplifier's speaker output connectors.
- 2) Turn off all processing (bass/treble, loudness, EQ, etc.) on the source unit, processors (if used) and amplifier. Set the fader control to center position and the subwoofer level control to 3/4 of maximum (if used to feed the XD300/1v2).
- 3) Switch the "Input Voltage" switch to "Low" and turn the amplifier's "Input Sens." control all the way down.
- 4) Set the source unit volume to 3/4 of full volume. This will allow for reasonable gain overlap with moderate clipping at full volume.
- 5) Using the chart on this page, determine the target voltage for input sensitivity adjustment according to the nominal impedance of the speaker system connected to the amplifier outputs.
- 6) Verify that you have disconnected the speakers before proceeding. Play a track with an appropriate sine wave (within the frequency range to be amplified by the XD300/1v2) at 3/4 source unit volume.
- 7) Connect the AC voltmeter to the speaker output connectors of the amplifier. Make sure you test the voltage at the correct connectors

(+ and -).

- 8) Increase the "Input Sens." control until the target voltage is observed with the voltmeter.
- 9) Once you have adjusted the XD300/1v2 to its maximum low-distortion output level, reconnect the speaker(s). The "Input Sens." controls can now be adjusted downward if the amplifier requires attenuation to achieve the desired system balance.

! IMPORTANT

Do not increase any "Input Sens." setting for any amplifier channel or channel pair in the system beyond the maximum level established during this procedure. Doing so will result in audible distortion and possible speaker damage.

It will be necessary to re-adjust the "Input Sens." if any equalizer boost is activated after setting the "Input Sens." with this procedure. This applies to any EQ boost circuit, including source unit tone controls or EQ circuits. EQ cuts will not require re-adjustment.

Nom. Impedance	Target AC Voltage
4Ω	28.3 V
3Ω	27.4 V
2Ω	24.5 V
1Ω	Not Recommended

APPENDIX B:
Precise Frequency Selection Chart

"FILTER FREQ" AMP FILTER		
Detent Number	Panel Marking	Actual Freq.
Full counter-clockwise: 53		
01		.53
02	"50"	.53
03		.54
04		.54
05		.55
06		.57
07		.59
08	"60"	.61
09		.63
10		.65
11		.67
12		.70
13		.72
14		.75
15		.78
16	"80"	.81
17		.85
18		.88
19		.93
20	"12 o'clock"	.97
21		1.02
22		1.07
23		1.13
24	"120"	1.20
25		1.27
26		1.35
27		1.44
28		1.56
29		1.69
30		1.84
31		2.03
32	"200"	2.27
33		2.54
34		2.90
35		3.37
36		3.92
37		4.26
38	"500"	4.47
39		4.67
Full-clockwise: 470		

APPENDIX C:
XD300/1v2 Specifications

General Specifications:

Recommended Fuse Value: 30A
 Recommended Fuse Type: MAXI® or AGU

Input Sections:

No. of Inputs: One Stereo Pair
 Input Type: Differential-balanced with RCA jack inputs
 Input Range: 200mV -8V RMS

Amplifier Section:

Amplifier Topology: NexD™ High Speed Class D
 Power Supply: Unregulated MOSFET switching type

Rated Power at 14.4V with less than 1% THD+Noise (20Hz - 20 kHz) RMS Method

200W RMS x 1 @ 4 ohms
 250W RMS x 1 @ 3 ohms
 300W RMS x 1 @ 2 ohms

Rated Power @ 12.5V with less than 1% THD + Noise (20Hz - 20 kHz) RMS Method

160W RMS x 1 @ 4 ohms
 210W RMS x 1 @ 3 ohms
 270W RMS x 1 @ 2 ohms

Signal to Noise Ratio:

>100 dB referred to rated power
 (A-weighted, 20 Hz-20 kHz noise bandwidth)
 >80 dB referred to 1W
 (A-weighted, 20 Hz-20 kHz noise bandwidth)

Frequency Response: 10 Hz - 1 kHz (+0, -1dB)

Damping Factor:

>120 @ 4 ohms / 50 Hz
 >60 @ 2 ohms / 50 Hz

Amplifier Filters:

Amplifier Low-Pass Filter:

12 dB/octave Butterworth or 24 dB/octave Linkwitz-Riley with continuously variable cutoff frequency selection from 50 - 500 Hz (defeatable).

Preamp Output:

Buffered pass-through type.

Dimensions(LxWxH):

6.85" x 7.09" x 2.05" (174mm x 180mm x 52mm)

Due to ongoing product development, all specifications are subject to change without notice.

APPENDIX D: TROUBLESHOOTING

“How do I properly set the input sensitivity on my amplifier?”

Please refer to Appendix A (page 12) to set the input sensitivity for maximum, low-distortion output.

“My amplifier doesn’t turn on.”

Check the fuse, not just visually, but with a continuity meter. It is possible for a fuse to have poor internal connections that cannot be found by visual inspection. It is best to take the fuse out of the holder for testing. If no problem is found with the fuse, inspect the fuse holder

Check the integrity of the connections made to each of the “+12VDC”, “Ground”, and “Remote” terminals. Ensure that no wire insulation is pinched by the terminal set screw and that each connection is tight.

Check to make sure there is +12V at the “Remote” connection of the amplifier. In some cases, the turn-on lead from the source unit is insufficient to turn on multiple devices and the use of a relay is required. To test for this problem, jump the “+12VDC” wire to the “Remote” terminal to see if the amplifier turns on.

“I hear a repetitive ticking or popping sound coming out of the speaker(s).”

Check the speaker wires for a possible short, either between the positive and negative leads or between either speaker lead and the vehicle’s chassis ground. If a short is present, you will experience distorted and/or attenuated output. The “Status LED” will turn amber in this situation. It may be helpful to disconnect the speaker wires from the amplifier and use a different set of wires connected to a test speaker.

Check the nominal load impedance to verify that of the amplifier is driving a load equal to or greater than 2 ohms.

“My amplifier’s output fluctuates when I tap on it or hit a bump.”

Check the connections to the amplifier. Make sure that the insulation for all wires has been stripped back far enough to allow a good contact area inside the terminal block.

Check the input connectors to ensure that they all are making good contact with the input jacks on the amplifier.

“My amplifier shuts off once in a while, usually at higher volumes.”

Check your voltage source and grounding point. The power supply of the XD300/1v2 will operate with charging system voltages down to 10V. Shutdown problems at higher volume levels can occur when the charging system voltage (or remote turn-on voltage) drops below 10V. These dips can be of very short duration making them extremely difficult to detect with a common DC voltmeter. To ensure proper voltage, inspect all wiring and termination points. It may also be necessary to upgrade the ground wire connecting the battery to the vehicle's chassis and the power wire connecting the alternator to the battery. Many vehicles employ small (10 AWG - 6 AWG) wire to ground the battery to the vehicle's chassis and to connect the alternator to the battery. To prevent voltage drops, these wires should be upgraded to 4 AWG when installing amplifier systems with main fuse ratings above 60A. Grounding problems are the leading cause of misdiagnosed amplifier “failures.”

“My amplifier turns on, but there is no output.”

Check the input signal using an AC voltmeter to measure the voltage from the source unit while an appropriate test tone is played through the source unit (disconnect the input cables from the amplifier prior to this test). The frequency used should be in the range that is to be amplified by the amplifier (example: 50 Hz for a sub bass application or 1 kHz for a full range / high-pass application). A steady, sufficient voltage (between 0.2 and 8.0-volts) should be present at the output of the signal cables.

Check the output of the amplifier. Using the procedure explained in the previous check item (after plugging the input cables back into the amplifier) test for output at the speaker outputs of the amplifier. Unless you enjoy test tones at high levels, it is a good idea to remove the speaker wires from the amplifier while doing this. Turn the volume up approximately halfway. 5 volt AC or more should be measured at the speaker outputs. This output level can vary greatly between amplifiers but it should not be in the millivolt range with the source unit at half volume. If you are reading sufficient voltage, check your speaker connections as explained below.

Check to ensure that the speaker wires are making a good connection with the metal inside the terminal block. The speaker wire connectors are designed to accept up to 8 AWG wire. Make sure to strip the wire to allow for a sufficient connection with the metal inside the terminal block.

INSTALLATION NOTES:

Use this diagram to document your amplifier's switch and control positions.

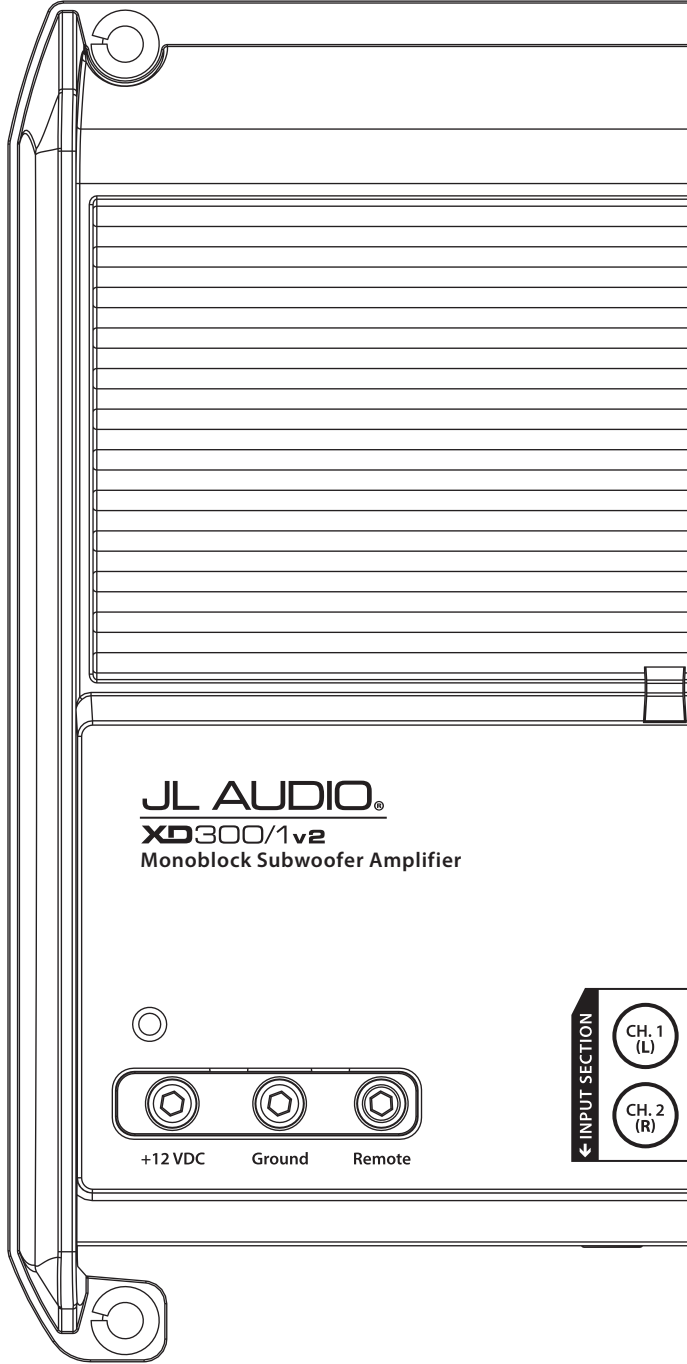

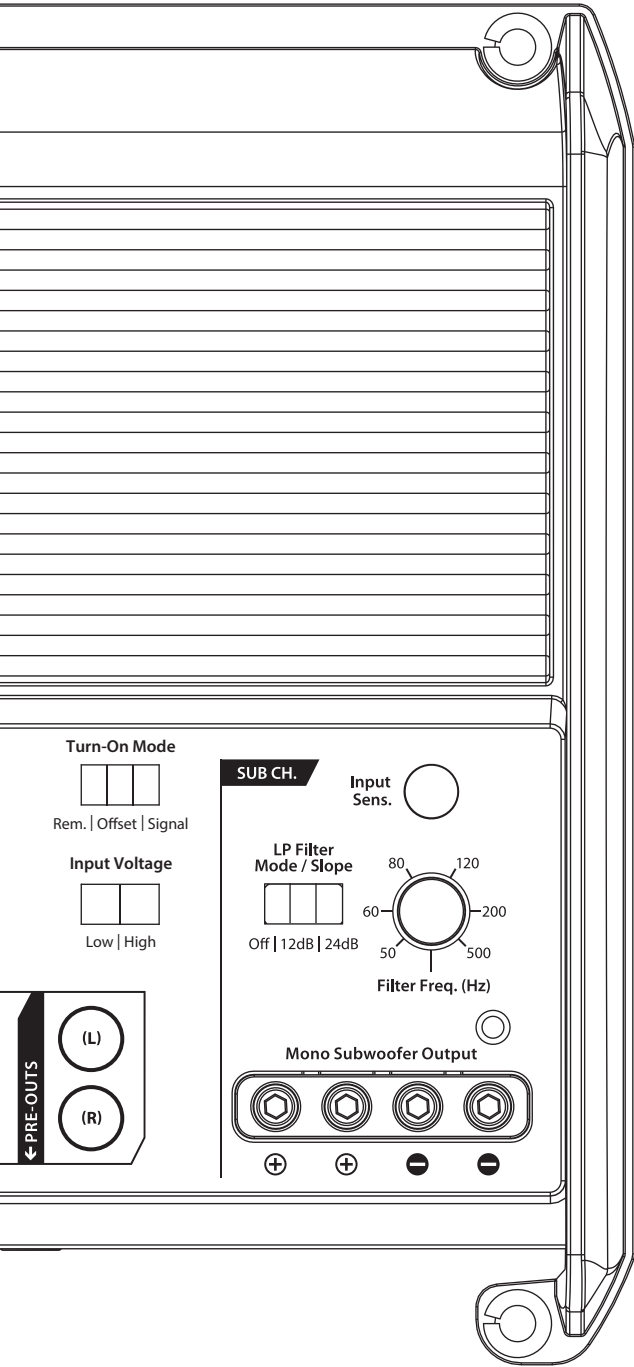

Turn-On Mode



Rem. | Offset | Signal

Input Voltage



Low | High

SUB CH.



LP Filter Mode / Slope



Off | 12dB | 24dB

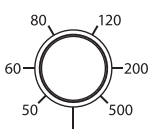

Filter Freq. (Hz)

Mono Subwoofer Output

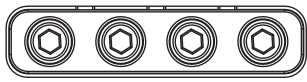

PRE-OUTS



INSTALLATION NOTES:

LIMITED WARRANTY - AMPLIFIERS (USA)

JL AUDIO warrants this product to be free of defects in materials and workmanship for a period of two (2) years. The warranty is extended to three (3) years total if installation is performed by an authorized JL Audio dealer using a JL Audio Premium Power Connection System for power wiring.

This warranty is not transferrable and applies only to the original purchaser from an authorized JL AUDIO dealer. Should service be necessary under this warranty for any reason due to manufacturing defect or malfunction, JL AUDIO will (at its discretion), repair or replace the defective product with new or remanufactured product at no charge. Damage caused by the following is not covered under warranty: accident, misuse, abuse, product modification or neglect, failure to follow installation instructions, unauthorized repair attempts, misrepresentations by the seller. This warranty does not cover incidental or consequential damages and does not cover the cost of removing or reinstalling the unit(s). Cosmetic damage due to accident or normal wear and tear is not covered under warranty.

Warranty is void if the product's serial number has been removed or defaced.

Any applicable implied warranties are limited in duration to the period of the express warranty as provided herein beginning with the date of the original purchase at retail, and no warranties, whether express or implied, shall apply to this product thereafter. Some states do not allow limitations on implied warranties, therefore these exclusions may not apply to you. This warranty gives you specific legal rights, and you may also have other rights which vary from state to state.

If you need service on your JL AUDIO product:

All warranty returns should be sent to JL AUDIO's Amplifier Service Facility freight-prepaid through an authorized JL AUDIO dealer and must be accompanied by proof of purchase (a copy of the original sales receipt). Direct returns from consumers or non-authorized dealers will be refused unless specifically authorized by JL AUDIO with a valid return authorization number.

Warranty expiration on products returned without proof of purchase will be determined from the manufacturing date code. Coverage may be invalidated as this date is previous to purchase date. Non-defective items received will be returned freight-collect. Customer is responsible for shipping charges and insurance in sending the product to JL AUDIO. Freight damage on returns is not covered under warranty.

For Service Information in the U.S.A. please call

JL Audio Customer Service: (954) 443-1100

9:00 AM – 5:30 PM (Eastern Time Zone)

JL Audio, Inc

10369 North Commerce Pkwy.

Miramar, FL 33025

(do not send product for repair to this address)

International Warranties:

Products purchased outside the United States of America are covered only by that country's distributor and not by JL Audio, Inc.